



# DATA SHEET

SPEC. NO. : SZ20073001  
DATE : 2020/07/30  
REV. : A/0

Approved By:

Checked By:

Prepared By:





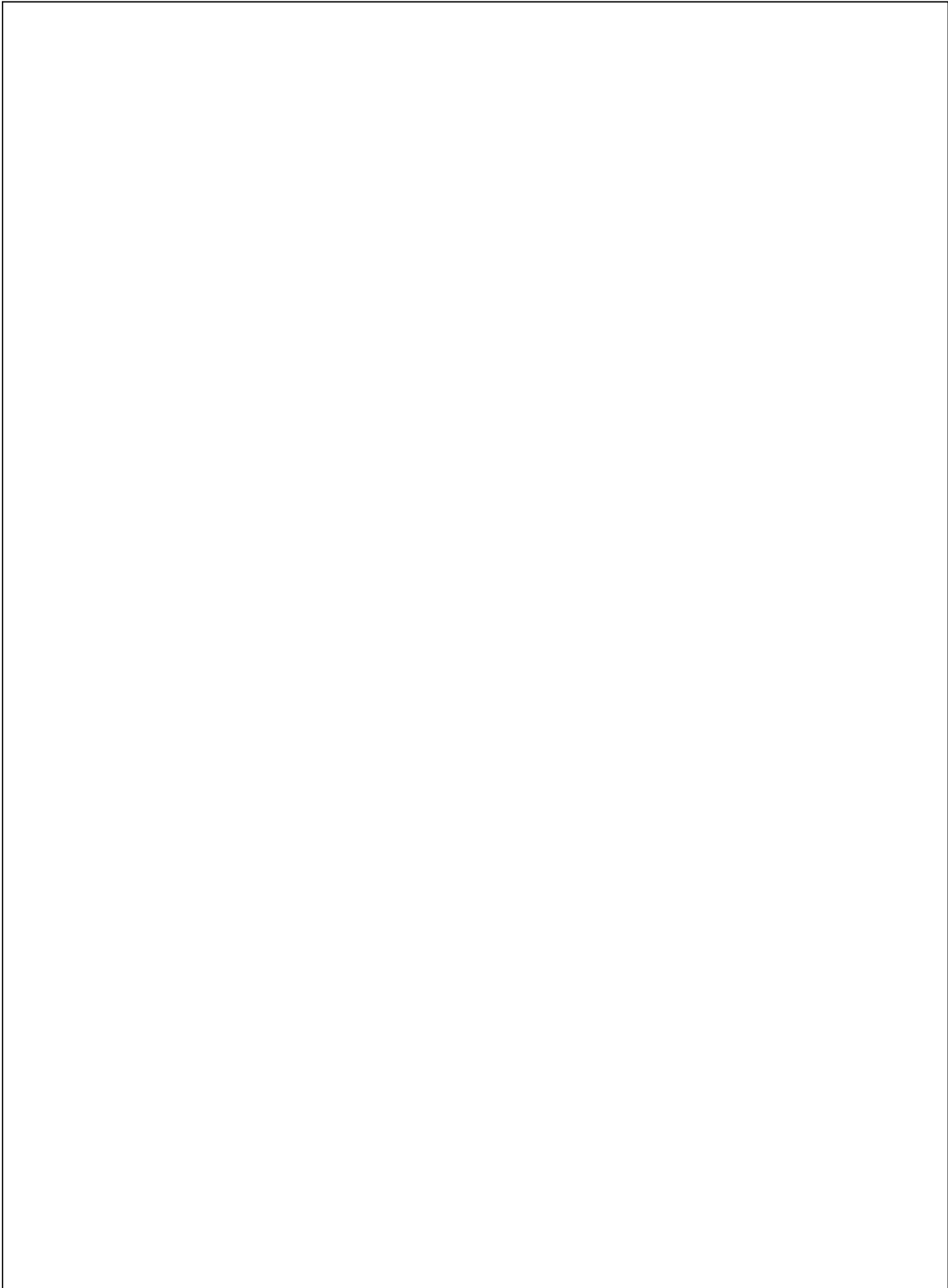

55103  
W

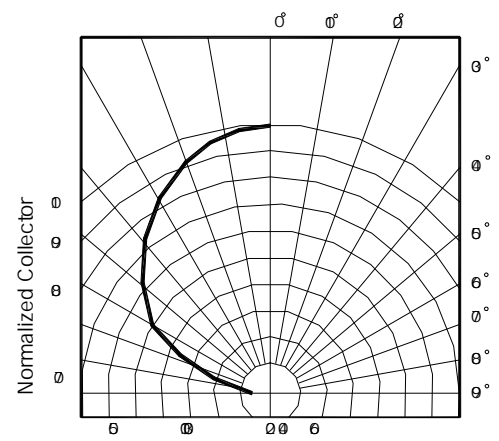
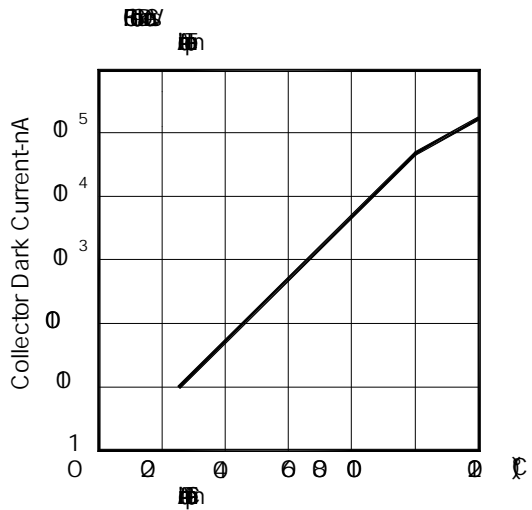
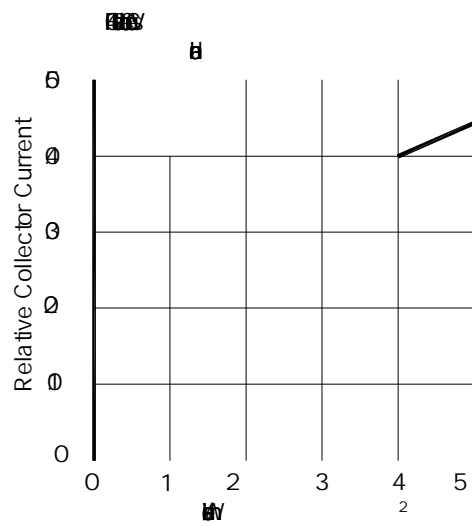
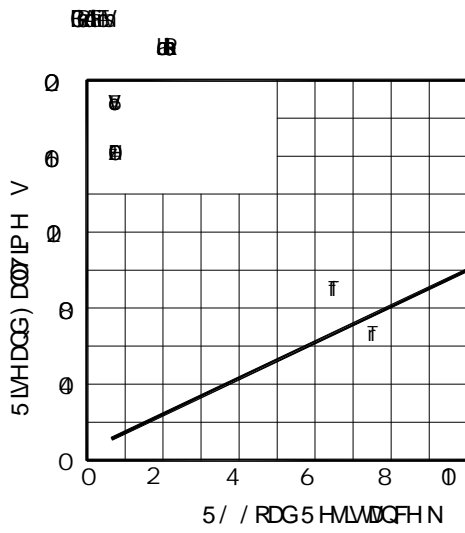
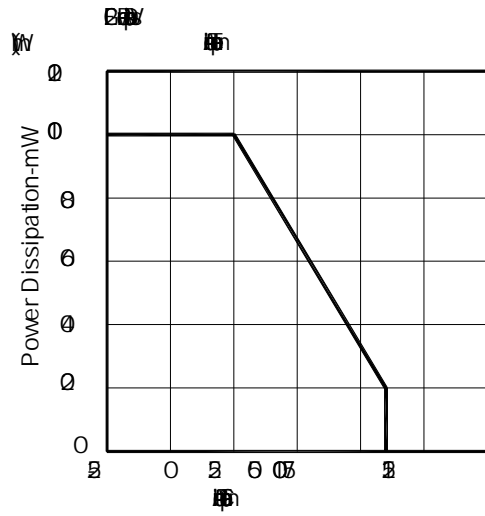
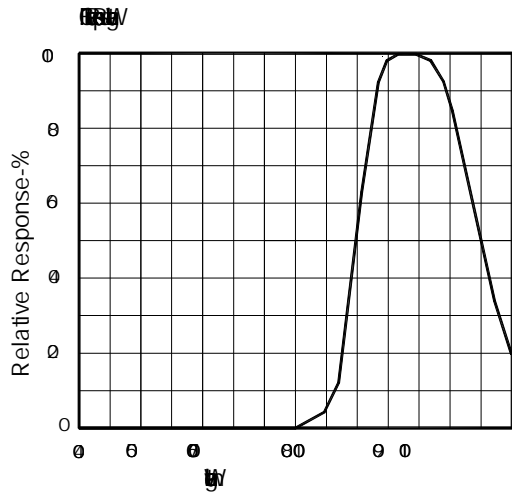

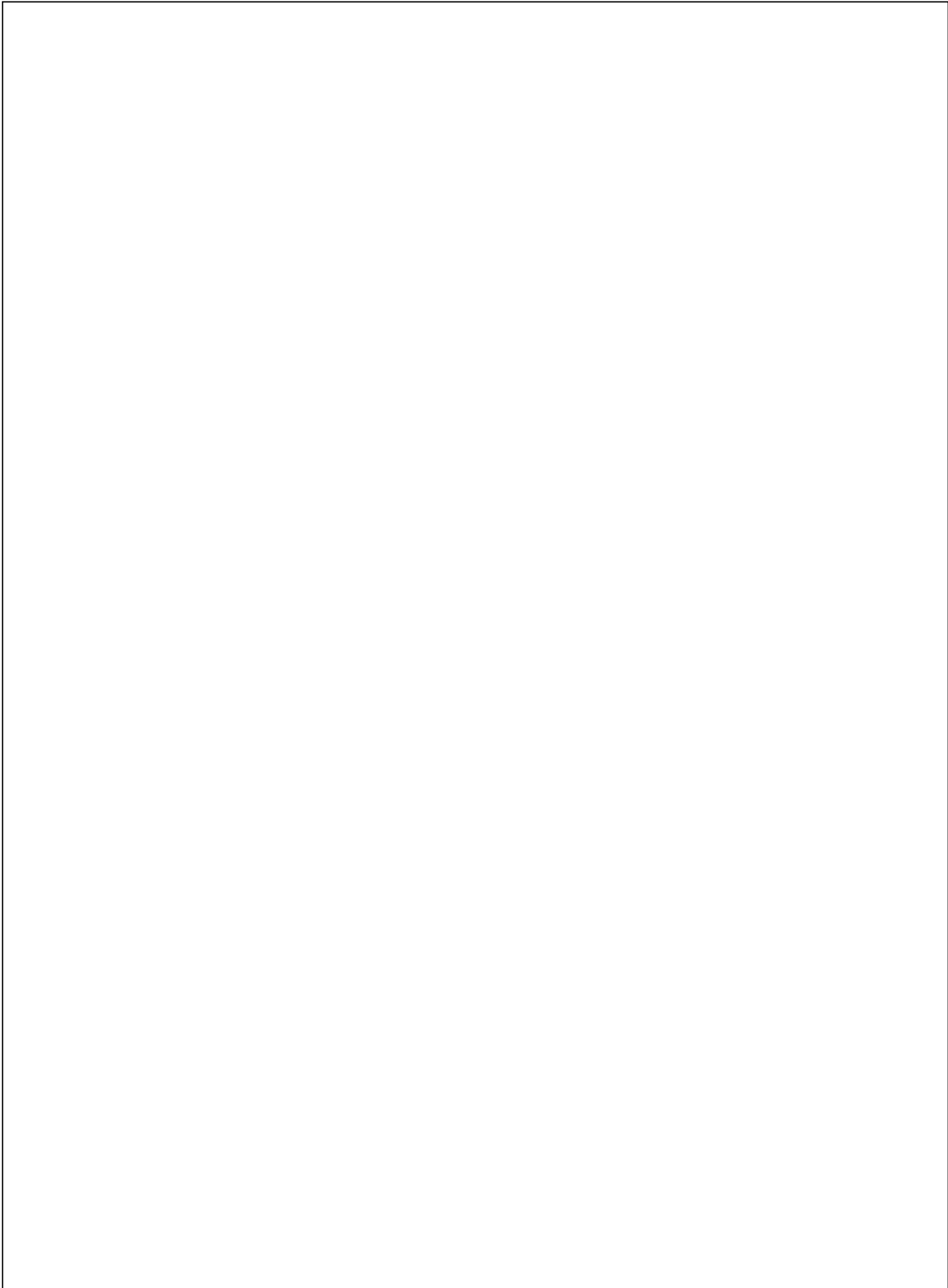

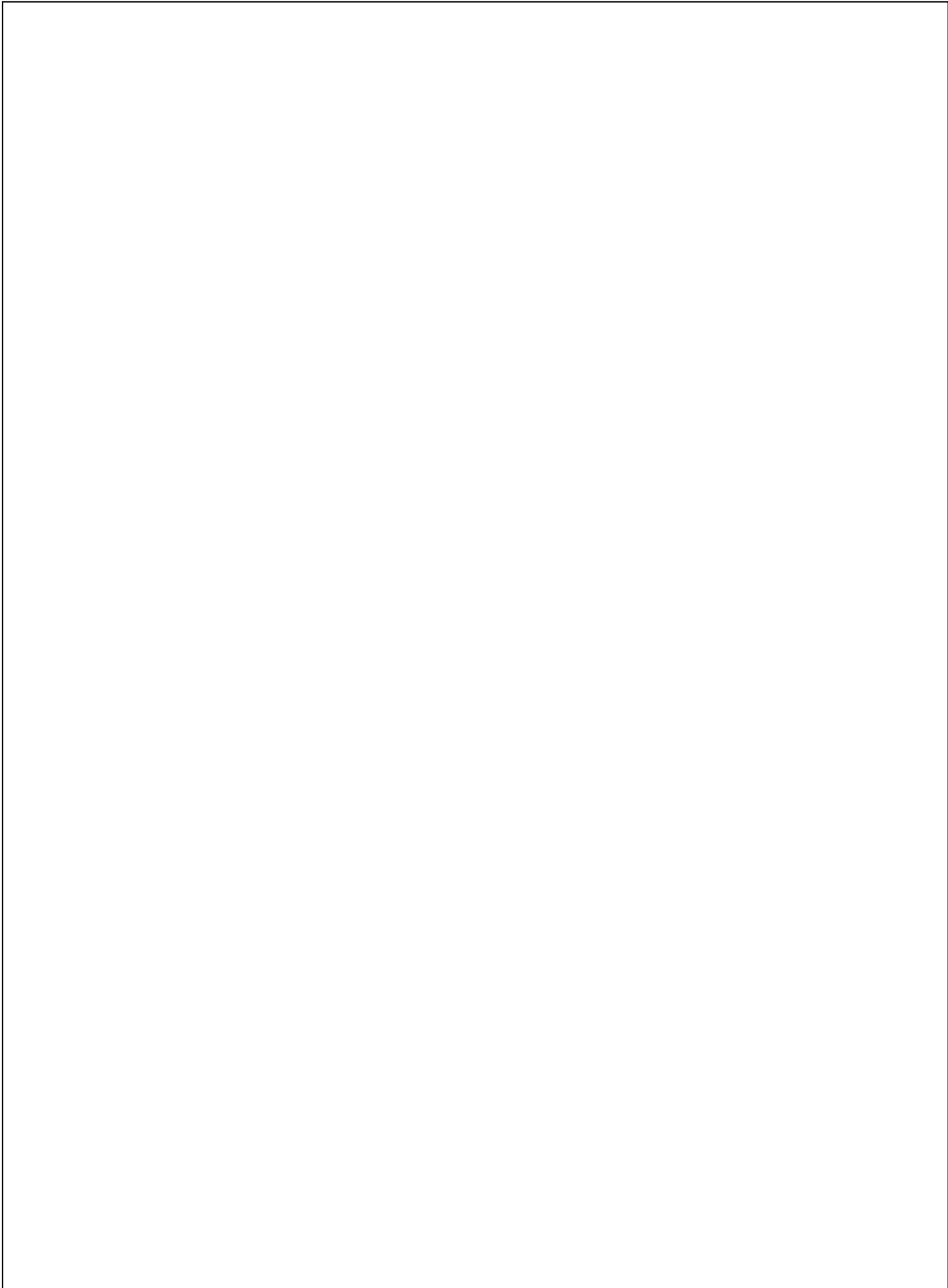

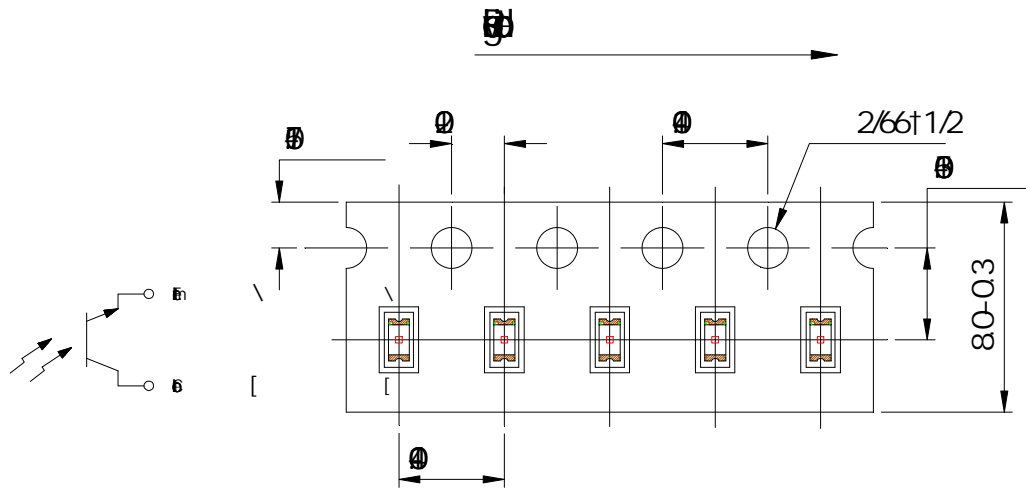

Tolerance unless mentioned is  $\pm 0.1\text{mm}$ ; Unit = mm

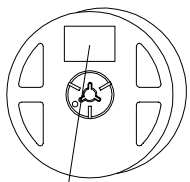

LIGHT universal Label

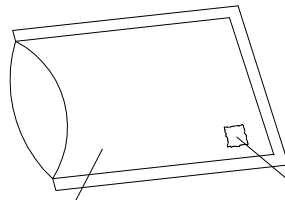

Aluminum moisture-proof bag

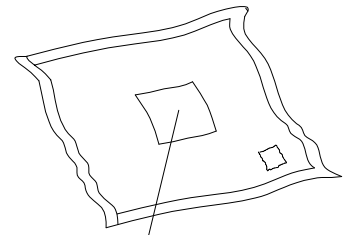
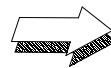

Desiccant

Customer defined Label or LIGHT universal Label



⑤

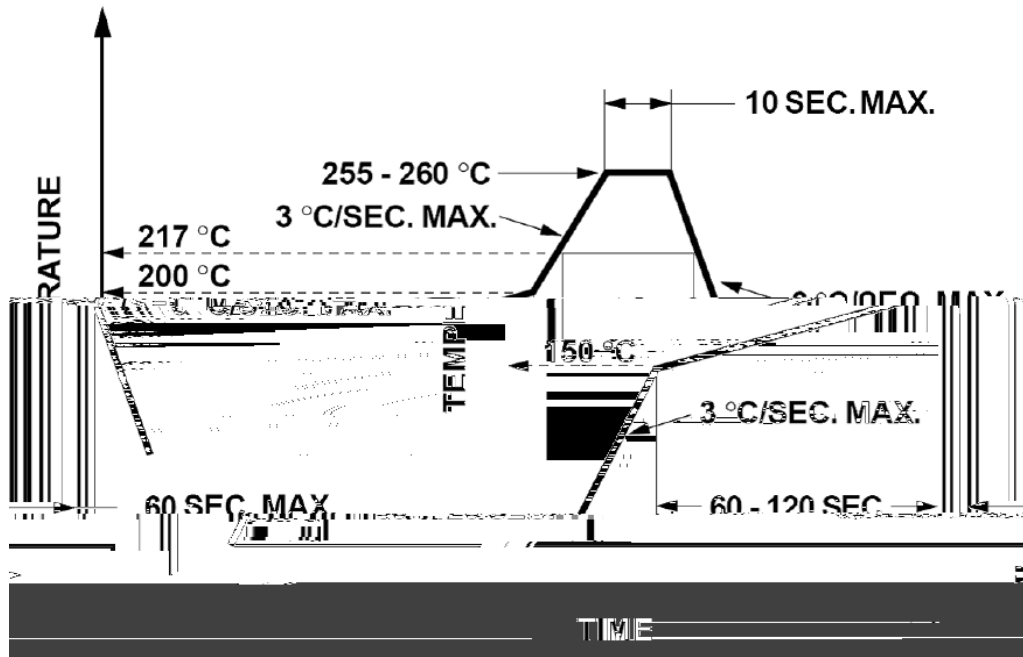

1. Reflow soldering should not be done more than two times.
2. When soldering, do not put stress on the LEDs during heating.

⑥

1. When hand soldering, the temperature of the iron must less than 300 seconds
2. The hand solder should be done only once.

⑦

Repair should not be done after the LEDs have been soldered. When repairing is unavoidable, a double-head soldering iron should be used (as below figure). It should be confirmed beforehand whether the characteristics of LEDs will or will not be damaged by repairing.

