

SL-T3528PT-940-1.4

PHOTO TRANSISTOR

DATA SHEET

SPEC. NO. : SZ17101702
DATE : 2020/03/02
REV. : A/3

Approved By:

Checked By:

Prepared By:

Features

- Pb free product—RoHS compliant
- High Photo Sensitivity
- Reliable and rugged
- Long life – solid state reliability
- Sensitivity angle: 120°

Package Dimension

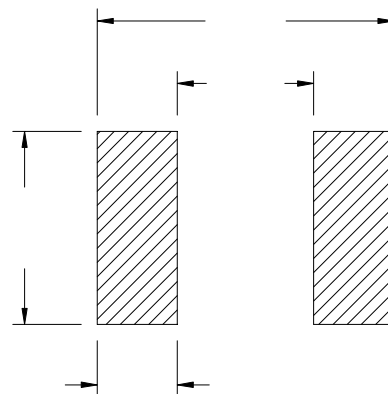
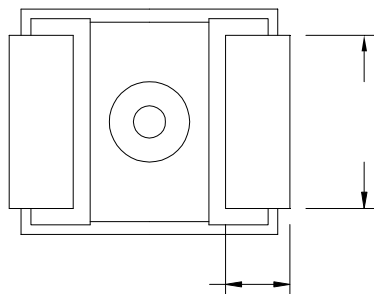
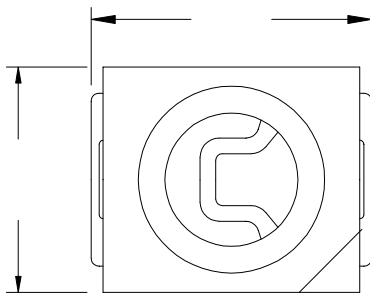

| Part NO. | Chip Material | Lens Color |
|--------------------|---------------|-------------|
| SL-T3528PT-940-1.4 | Silicon | Water Clear |

Notes:

1. All dimensions are in millimeters.
2. Tolerance is 0.10mm unless otherwise noted.
3. Specifications are subject to change without notice.

Absolute Maximum Ratings at Ta=25

| Parameter | MAX. | Unit |
|--|-------------------------|------|
| Power Dissipation | 100 | mW |
| Collector-Emitter Voltage | 30 | V |
| Emitter-Collector Voltage | 5 | V |
| Moisture Sensitivity Level ^{*1} | 5a | |
| Operating Temperature | -40 to + 85 | |
| Storage Temperature | -40 to + 100 | |
| IR Reflow Temperature ^{*3} | 260 for 10 Seconds MAX. | |

1. Storage

- (1). Storage requirements before vacuum bag opened: Temperature<30 , Humidity<65%RH;
- (2). Check air leakage and vacuum bag damage before opened. If there is any issue found, check the humidity indicator card immediately after bag opened:
 - a. If color changes on “10% circle” of the humidity indicator card only and not the circles of 20% and above, components can be used without additional handling;
 - b. If color changes on both 10% and 20% circles but not the circles of 30% and above, components must be dehumidified according to the conditions of bullet (5);
 - c. If color changes on 10%, 20%, and 30% circle or above, the product should be returned to the supplier for high temperature dehumidification;
- (3). After bag opened, manual soldering or reflow process must follow the following requirements:
 - a. Complete soldering / reflow within 24 hours;
 - b. Requirements of working environment: Temperature<30 , Humidity<60%RH;
- (4). If the working condition is outside (3)a or (3)b requirement, the components must be dehumidified according to the conditions of bullet (5);
- (5). Low temperature dehumidification: temperature 60±5 24 hours;
- (6). Shelf life: 30 days. If it's over 30 days from the production date on the package label, the components must be dehumidified according to the condition of bullet (5). If customer is unable to dehumidify, return components to LIGHT for dehumidification.

2. Cleaning:

Use alcohol-based cleaning solvents such as isopropyl alcohol to clean the LED if necessary.

3. IR Reflow Temperature:

It is the Plate Temperature.

4. Caution in ESD:

Static Electricity and surge damages the LED. It is recommend to use a wrist band or anti-electrostatic glove when handling the LED. All devices, equipment and machinery must be properly grounded.

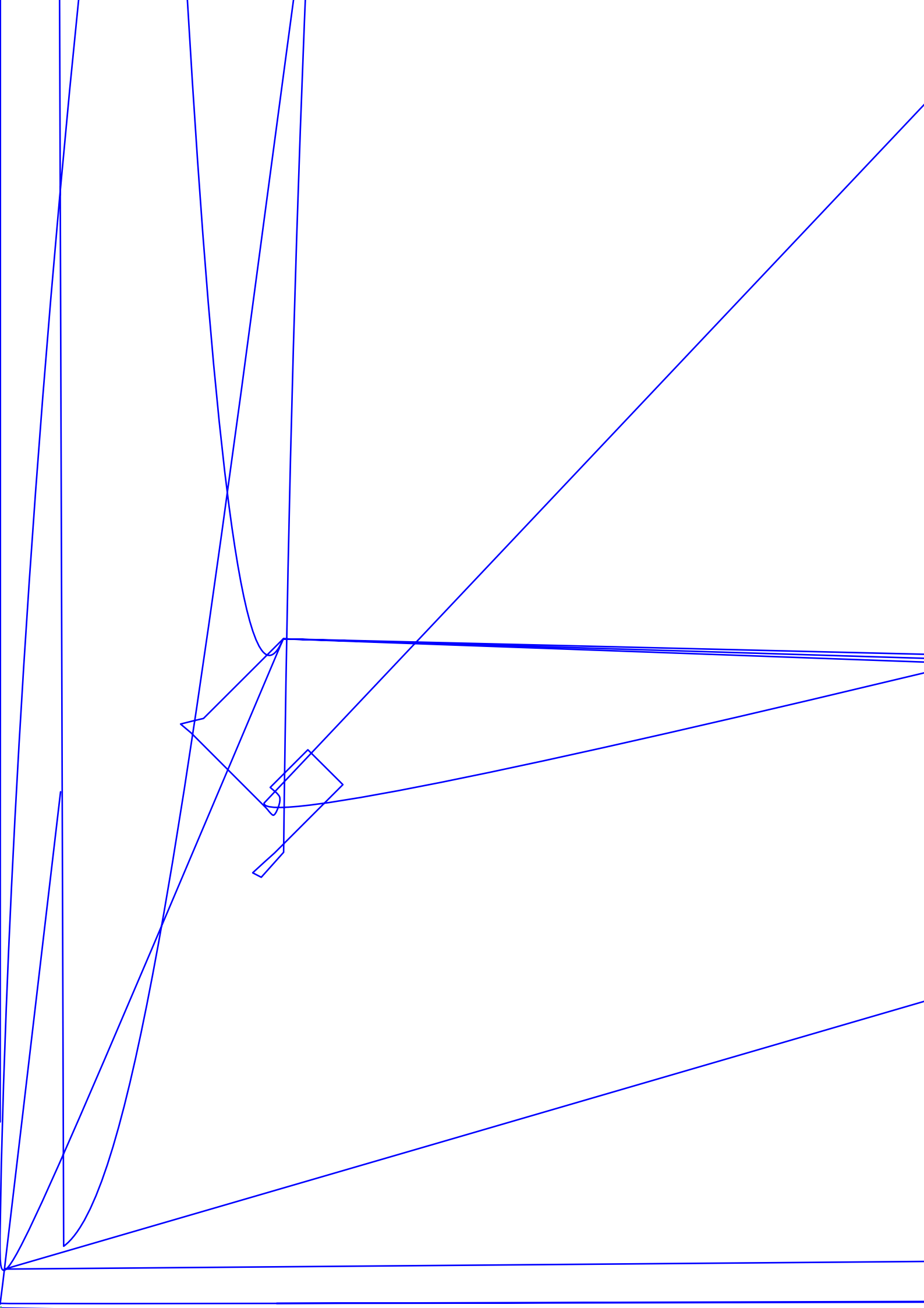

Typical Electrical / Optical Characteristics Curves (25 Ambient Temperature Unless Otherwise Noted)

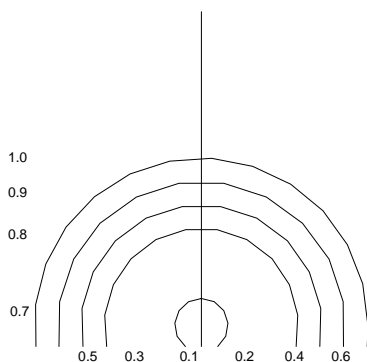
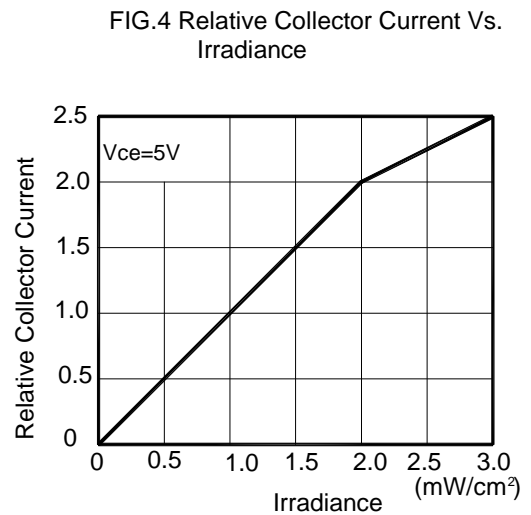
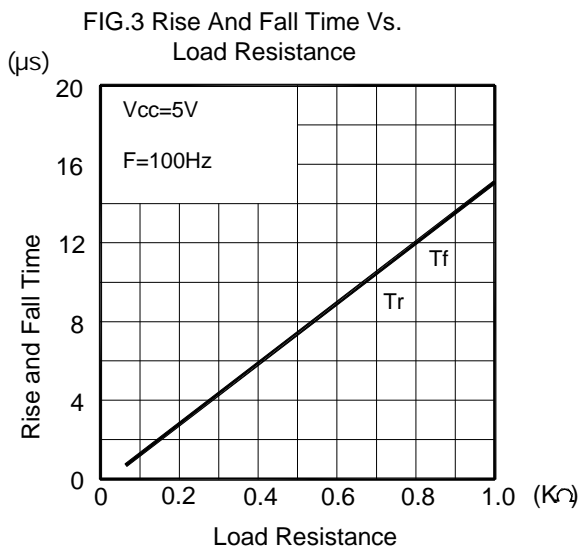
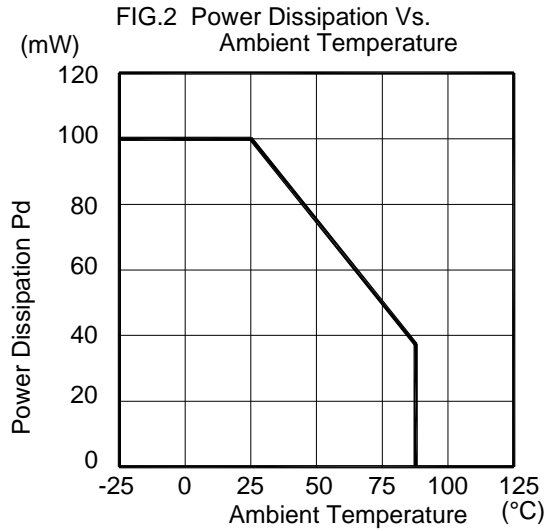
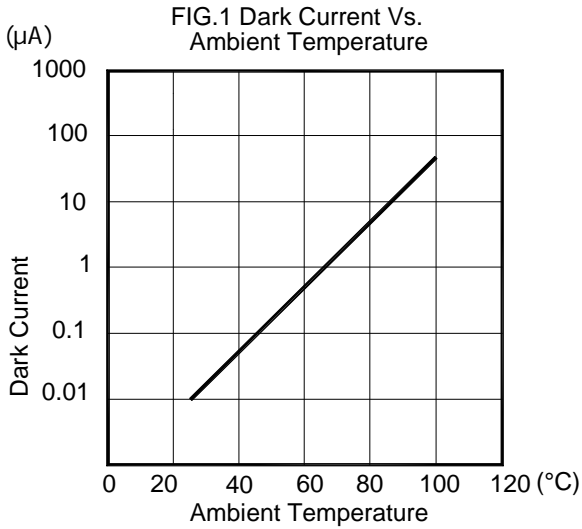

Photo Transistor Specification

●Commodity: Photo Transistor



●Ic(on) Bin Limits ($V_{CE}=5V$, $E_e=1mW/cm^2$, $p=940nm$)

| BIN CODE | Min.(mA) | Max.(mA) |
|----------|----------|----------|
| 1 | 1.8 | 2.16 |
| 2 | 2.16 | 2.59 |
| 3 | 2.59 | 3.1 |
| 4 | 3.1 | 3.72 |
| 5 | 3.72 | 4.85 |



NOTE: The Ic(on) guarantee should be added 15% tolerance.

Label Explanation

LIGHT Universal Label

| | | |
|-----------------------------|---|---|
| LIGHT | |  |
| Light Electronics CO., LTD. | | |
| MODEL NAME: _____ |  LOT NO.: _____ | |
| QUANTITY: _____ | | |
| BIN: _____ | | |
| PACKING DATE: _____ | | |
| REMARKS: _____ | | |

Customer Defined Label

| | | |
|-----------------------------|---|---|
| LIGHT | |  |
| Light Electronics CO., LTD. | | |
| MODEL NAME: _____ |  LOT NO.: _____ | |
| QUANTITY: _____ | | |
| BIN: _____ | | |
| PACKING DATE: _____ | | |
| CUSTOMER P/N: _____ | | |

| | |
|---------------|---------------|
| MODEL NAME/ | QUANTITY/ |
| BIN./ | PACKING DATE/ |
| CUSTOMER P/N/ | LOT NO./ |
| REMARKS/ | / |

Reel Dimensions

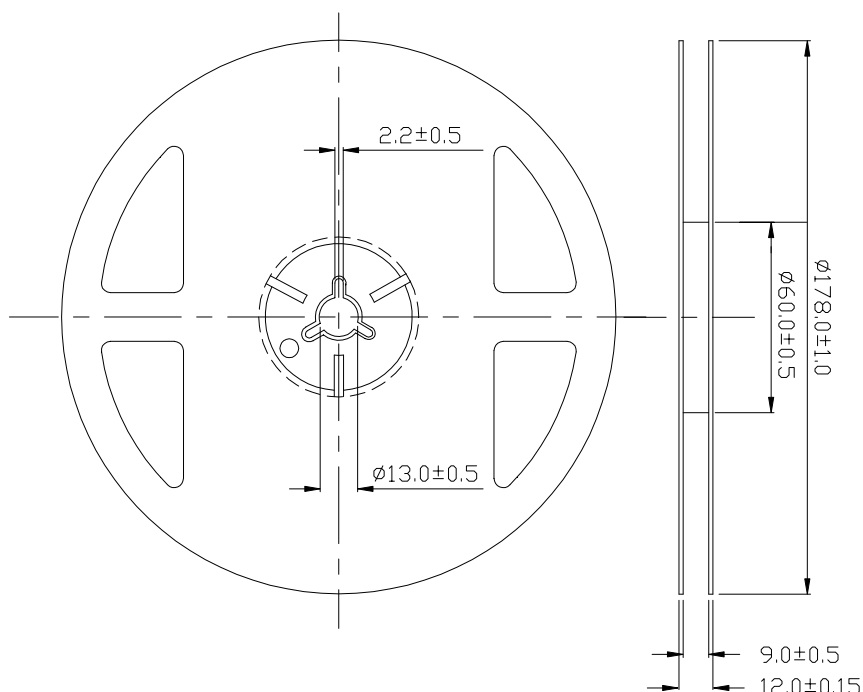

Note: Tolerance unless mentioned is $\pm 0.2\text{mm}$; Unit = mm

