

SL-T2528RGBIC-L110 DATA SHEET

SPEC.NO. : SZ18092602
DATE : 2018/09/26
REV. : A/0

Approved By:

Checked By:

Prepared By:

%

&

,

(

)

.....

,

,

,

(

*" D] b Zi bVh] cb

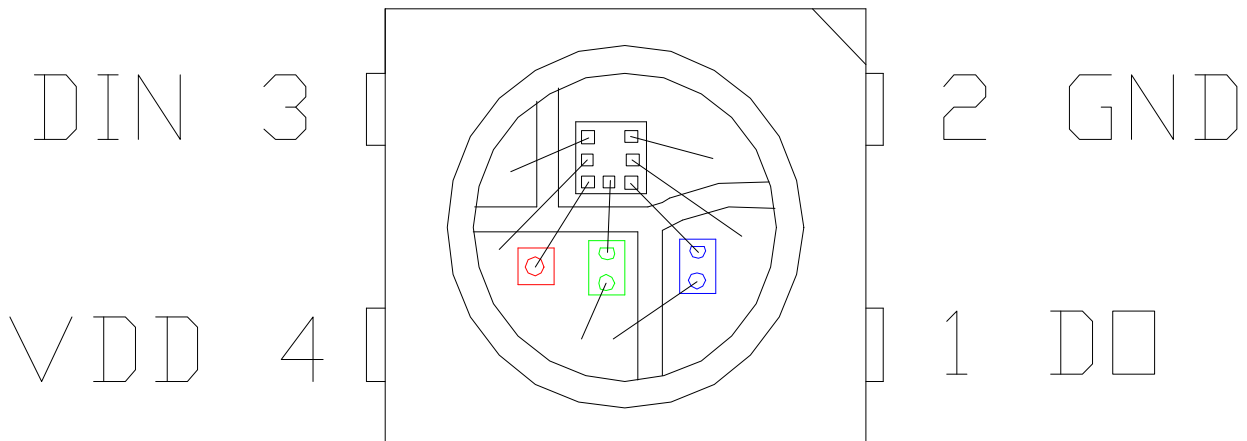

%	8C		
&	; B8		
'	8=B		
(J88		D76

+ " 9` YVhfc! cdh] WU` VXUFUVhYf] gh] Vg Uh HU1&) F; 6

=hYa	GraVc`	A]I	Hrd	AUI	I b] h	7cbX] h] cbg
8ca] bUbh kUj Y` Yb[h\`	E` X	;)&\$)&)	ba	=: 1%&a5
		F *&\$		*&)		
		6 (*)		(+\$		
@ a] bci g] bhYbg] hm	=J	; , \$\$		%&\$\$	aVK	=: 1%&a5
		F &\$\$		(\$\$		
		6 % \$		' \$\$		

L

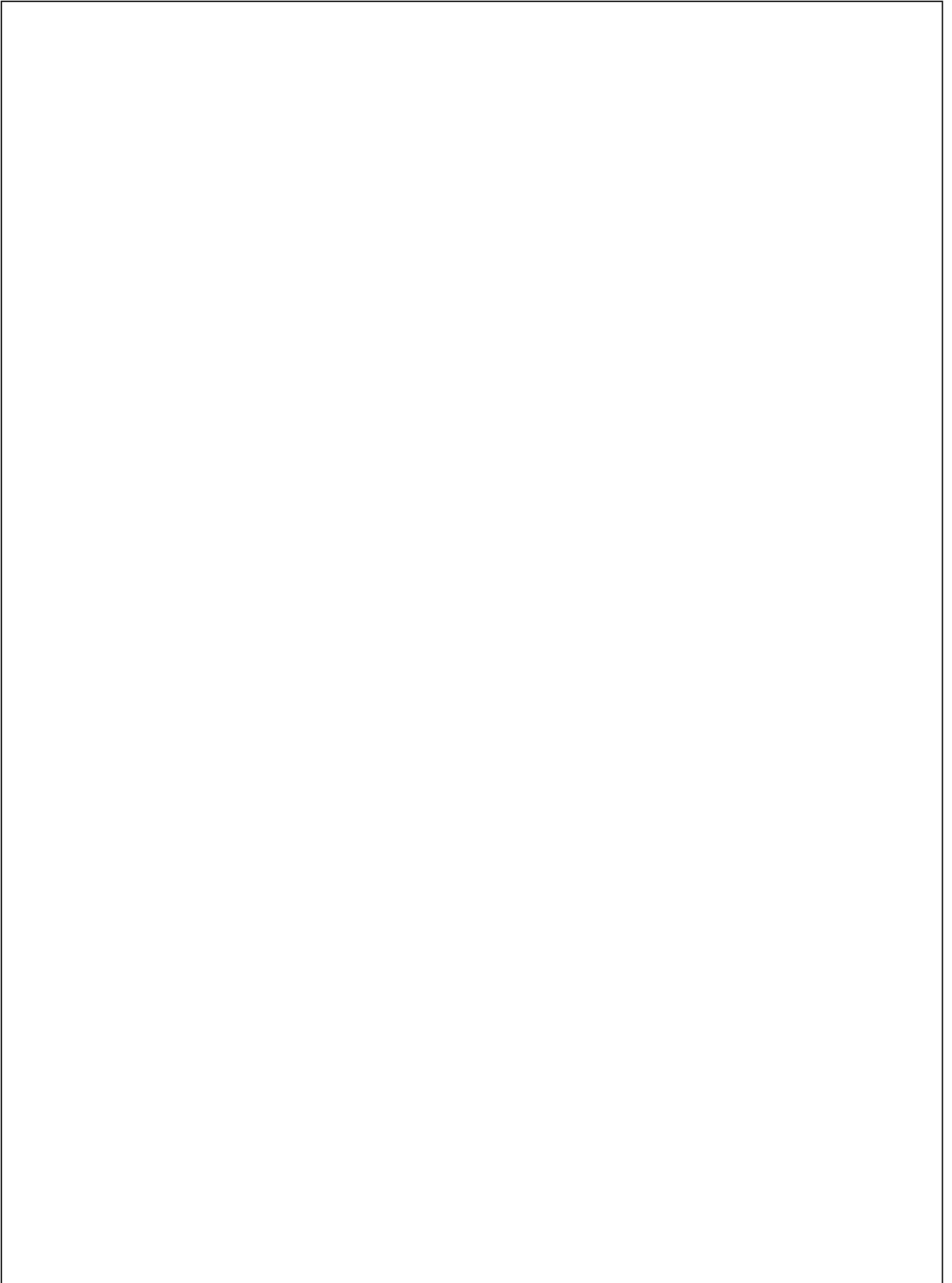

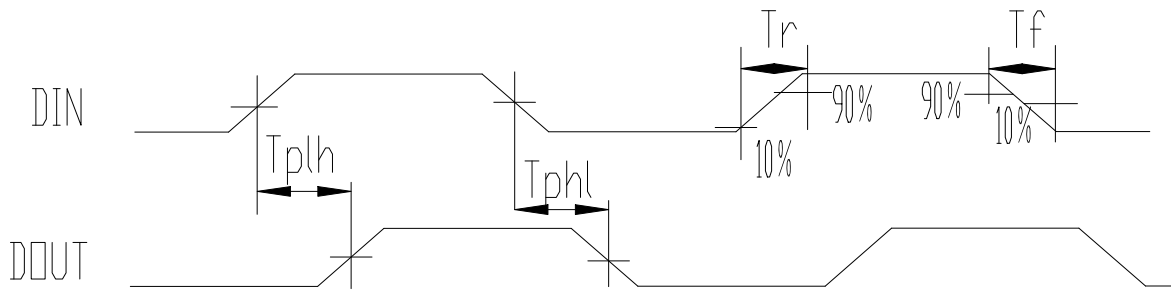

%% H\Y XU hU hfUbga] gg] cb h] aY

&) & F; 6=7					
H	7cXY	A] b	Hnd] W	AU	l b] h
HC<	\$	&()	&-)	'()	bg
HC@	\$)())-)	*()	bg
H%<	%)())-)	*()	bg
H%@	%	&()	&-)	'()	bg
Hfgh	FYgYh	, \$!!	!!	i g

%%" HYadcfU` kUj YZcfa Z][i fY

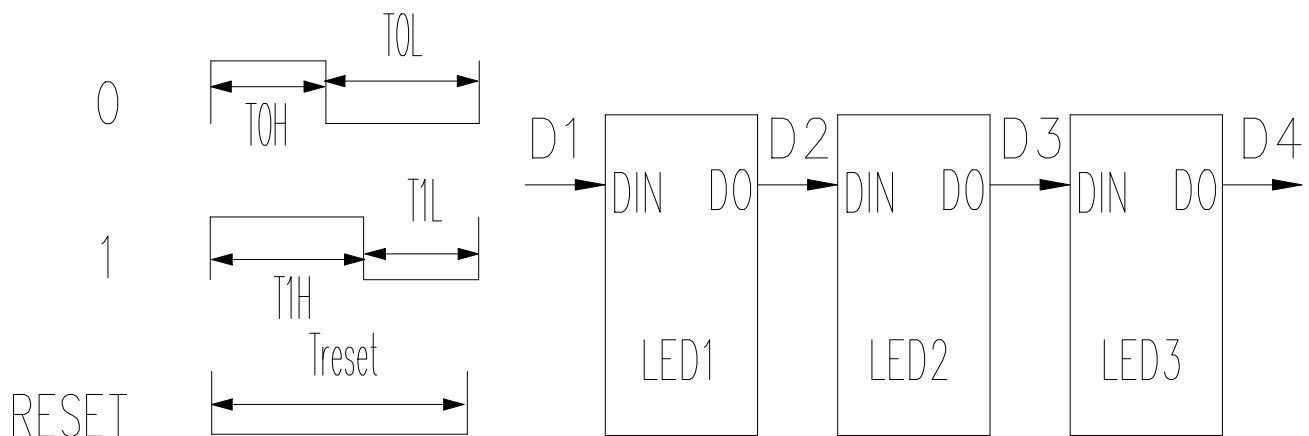

% " AcXY cZ XUhU hfUbga] gg] cb

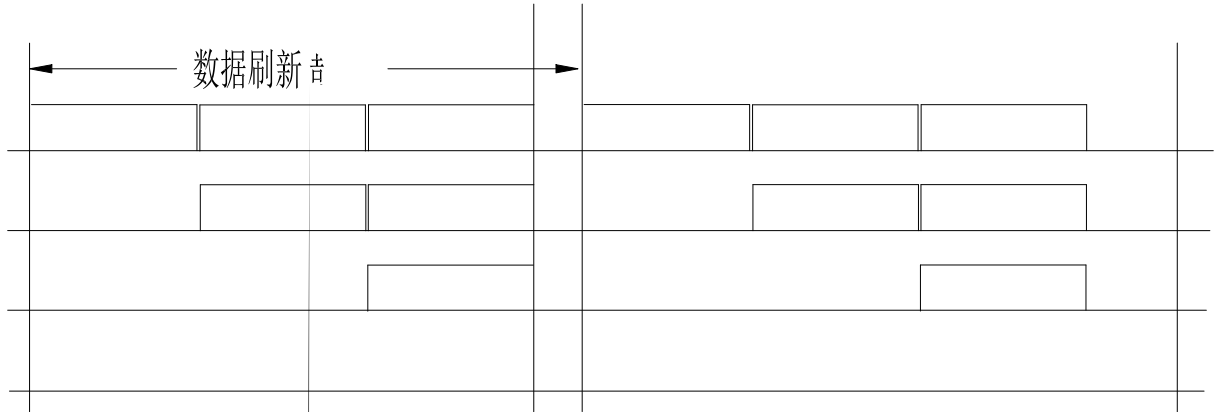

Gn

100%

100%

100%

100%



100%

100%

%" DUW_U[] b[GdYV\ Z] W\h] cbg

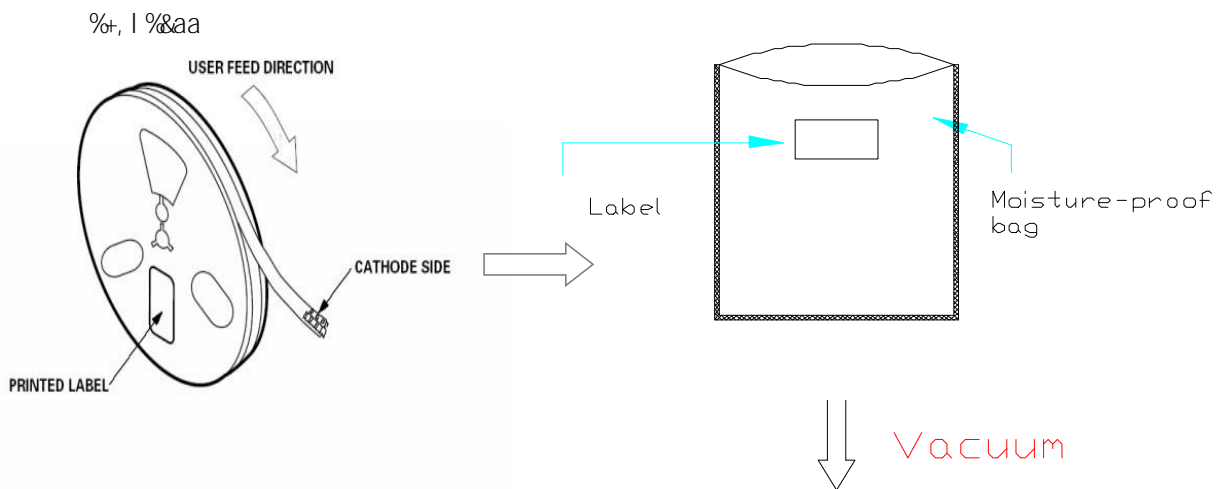
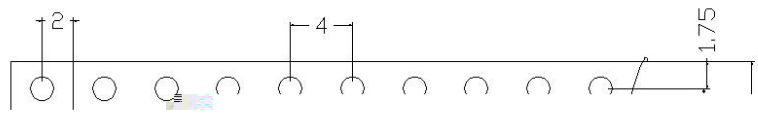
: YXX] b[8] fYVh] cb



LIGHT		
Light Electronics CO., LTD.		
MODEL NAME:	_____	 LOT NO.: _____
QUANTITY:	_____	
BIN:	_____	
PACKING DATE:	_____	
CUSTOMER P/N:	_____	

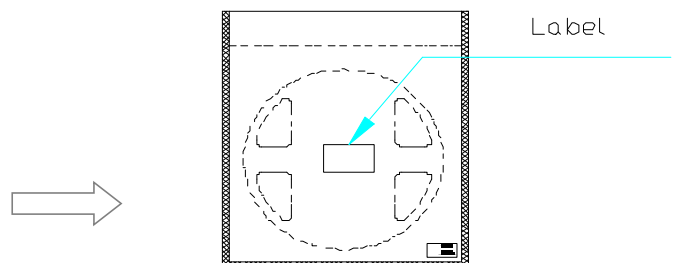

BchY. jc`iaY]g &\$\$\$dVg/

&\$\$\$dVg

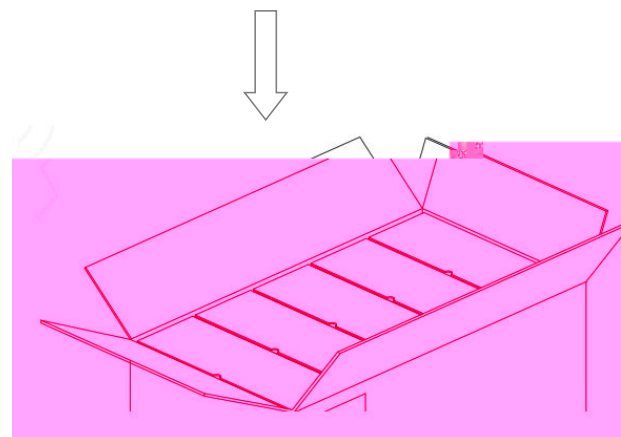

% " FY`]U]`]hm

H9GH =H9AG 5B8 F9GI @HG

	HYgh =hYa	FYZ" GhUbXUfX	HYgh 7cbX] h] cbg	BchY	7cbWi g] cb
%	FYZ` ck Gc` XYf] b[>9G8&&! 6%\$*	Hg` X1&(\$ ž%\$gYW	' h] aYg	\$#&&
&	HYadYfUhi fY 7mWY	>9G8&&! 5%\$(! &\$ ' \$a] b %&\$ ' \$a] b	&\$ \$ WmWY	\$#&&
,	HYfaU` G\cW_	>9G8&&! 5%\$*	! (\$ %&a] b %&) %&a] b	&\$ \$ WmWY	\$#&&
(<][\ HYadYfUhi fY GhcfU[Y	>9G8&&! 5%\$'	H,1%\$\$	%\$\$\$ \fg	\$#&&
)	@ck HYadYfUhi fY GhcfU[Y	>9G8&&! 5%%	H,1! (\$	%\$\$\$ \fg	\$#&&
*	DckYf hYadYfUhi fY 7mW] b[>9G8&&! 5%\$)	Cb) a] b! (\$ 2%&a] b 0%&a] b CZZ) a] b%\$\$ 2%&a] b	&\$ \$ WmWY	\$#&&
+	@]ZY HYgh	>9G8&&! 5%\$,	H,1&) = 1%&a5	%\$\$\$ \fg	\$#&&
,	<][\ <i a] X] hm <YUh @]ZY HYgh	>9G8&&! 5%\$%	*\$ F<1- \$i = 1%&a5	%\$\$\$ \fg	\$#&&

% " FYZ` ck dfcZ]`Y

GAB FYZ` ck Gc` XYf] b[=bghfi Vh] cbg

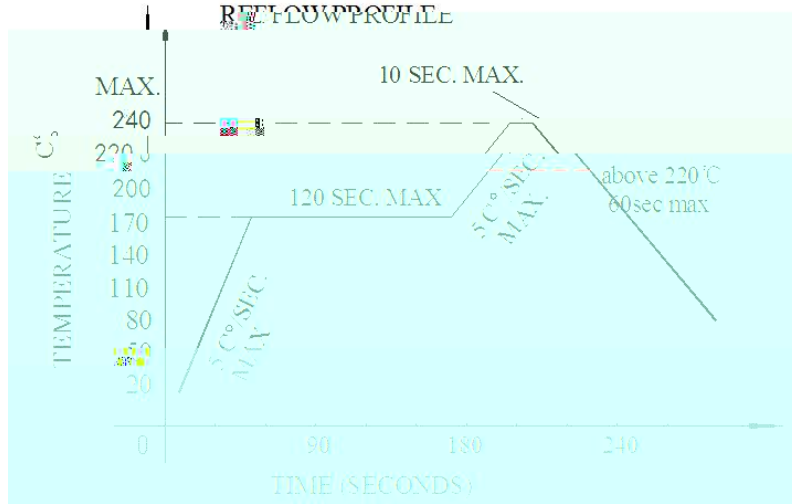

U" FYZ` ck gc` XYf] b[g\ci` X bch VY XcbY acfY h\Ub hkc h]aYg

&

V" K\Yb gc` XYf] b[žXc bch di h ghfYgg cb h\Y @98g Xi f] b[\YUh] b[

@98

Gc` XYf] b[] fcb

U" K\Yb \UbX gc` XYf] b[ž _YYd h\Y hYadYfUhi fY cZ h\Y] fcb i bXYf ' \$\$ ž UbX Uh h\Uh

hYadYfUhi fY _YYd h\Y h] aY i bXYf ' gYW

' \$\$

V" H\Y \UbX gc` XYf] b[g\ci` X VY XcbY cb` m U h] aY

FYkcf_

U" 7i ghcaYf ai gh Z] b] g\ fYkcf_ k] h\] b) gYWi bXYf & (\$

& (\$)

V" H\Y \YUX cZ] fcb WUb bch hci WX h\Y @98g

@98

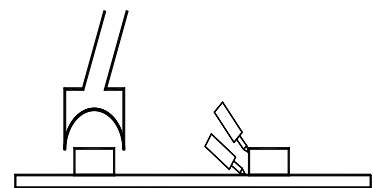

W Hk] b] \YUX hmdY] g dfZYffYX"

&\$" 75I H=CBG

BchY Zcf i gY

=b cfXYf hc Ybgi fY h\Uh =7 `Uad VYUXg UfY i gYX]b GAH dUhW\ fYZ` ck kY` X]b[UbX]b
h\Y i gY cZ h\Y dfcWgg m]Y` X UbX ghUV]`] hmcZ h\Y dfcXi Vhž h\Y Zc` `ck]b[dfcWXi fYg UfY
[REDACTED] UZhYf aUbm hYghg.

=7 GAH

U Glad` Y Yj U i Uh] cb. 6YWUi gY h\] g dfcXi Vh]g U Vi]` h!] b =7 dfcXi Vhž h\Y cj YfU` ` dfcWgg
]g X] ZZYfYbh Zfca Včbj Ybh] cbU` F; 6 dfcXi Vhž gc h\Y WghcaYf g] XY bYYXg hc Wffm ci h
U` ! fci bX j Yf] Z] WWh] cb Xi f] b[h\Y gUad` Y Yj U i Uh] cb hc Ybgi fY h\Y aUhW\] b[dYfZcfaUbW
cZ h\Y dfcXi Vh

=7 F; 6

V =bVča]b[aUhYf]U`]bgdYWh] cb. Ybgi fY h\Y j UW i a dUW] b[]g]bhUWh UbX h\YfY]g bc
j UW i a `YU_U[Y" =Z h\YfY]g j UW i a `YU_U[Yž d` YUgY VčbZ] fa k\Yh\Yf h\Y fYZ` ck kY` X]b[]g
UWbcfaU " =Z]h]g UWbcfaU ž d` YUgY fYhi fb hc h\Y ZUWhcfm Zcf \] [\! hYadYfUhi fY
XY\i a] X] Z] WWh] cb"

W I gY. D` YUgY VčbZ] fa h\YY\ h a

LIGHT

