

LG-256PT2C94F-908

PHOTO TRANSISTOR

DATA SHEET

SPEC. NO. : SZ20111602
DATE : 2021/03/29
REV. : A/2

Approved By:

Checked By:

Prepared By:

Features

- Pb free product—RoHS compliant
- High Photo Sensitivity
- General purpose leads
- Reliable and rugged
- Long life – solid state reliability

Package Dimension

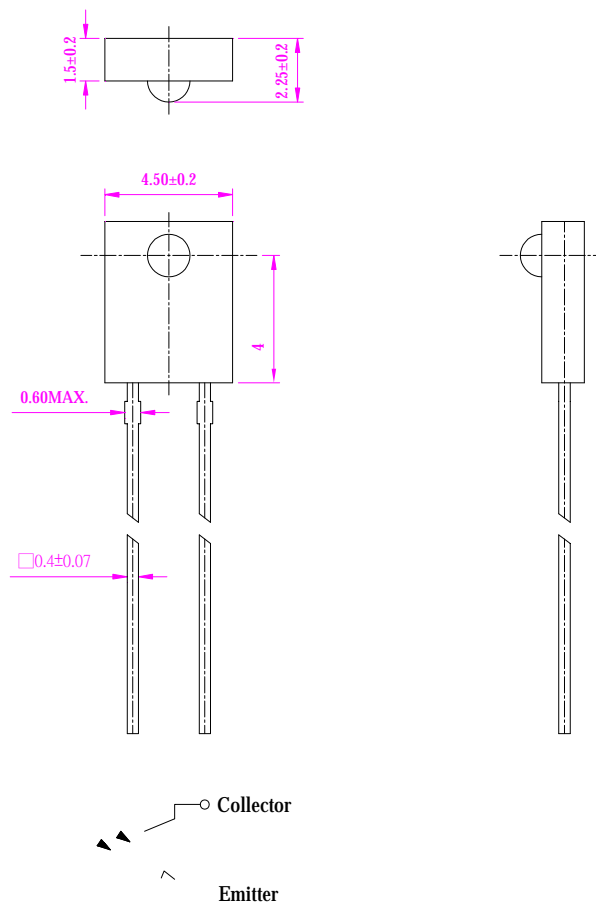

Part NO.	Chip Material	Lens Color
LG-256PT2C94F-908	Silicon	Water Clear

Notes:

1. All dimensions are in millimeters.
2. Tolerance is $\pm 0.20 \text{ mm}$ unless otherwise noted.
3. Protruded resin under flange is 1.0mm max.
4. Lead spacing is measured where the leads emerge from the package.
5. Specifications are subject to change without notice.

Electrical Optical Characteristics at Ta=25°C

PARAMETER	SYMBOL	MIN	TYP	MAX	UNITS	TEST CONDITIONS
Range of Spectral Bandwidth	0.5	400	---	1100	nm	---
Wavelength of Peak Sensitivity	P	---	860	---	nm	---
Collector- Emitter Breakdown Voltage	$V_{(BR)CEO}$	30	---	---	V	$I_C=0.1mA$ $E_e=0mW/cm^2$
Emitter-Collector Breakdown Voltage	$V_{(BR)ECO}$	5	---	---	V	$I_R=0.1mA$ $E_e=0mW/cm^2$
Collector- Emitter Saturation Voltage	$V_{CE(SAT)}$	---	---	0.4	V	$I_C=0.1mA$ $E_e=1.0mW/cm^2$
Rise Time	T_r	---	15	---	μS	$V_{CC}=5V$ $R_L=1K$ $I_C=1mA$
Fall Time	T_f	---	15	---	μS	$V_{CC}=5V$ $R_L=1K$ $I_C=1mA$
Viewing Angle	$2_{1/2}$	---	55	---	Deg.	---
Collector Dark Current	I_{CEO}	---	---	100	nA	$V_{CE}=10V$ $E_e=0mW/cm^2$
On State Collector Current	$I_{C(ON)}$	2.2	4.5	---	mA	$V_{CE}=5V$ $E_e=1.0mW/cm^2$ $p=940nm$

Note:

- $2_{1/2}$ is the off-axis angle at which the $I_{C(ON)}$ is half the axial $I_{C(ON)}$.
- The $I_{C(ON)}$ guarantee should be added $\pm 15\%$ tolerance.

Recommended Wave Soldering Profile

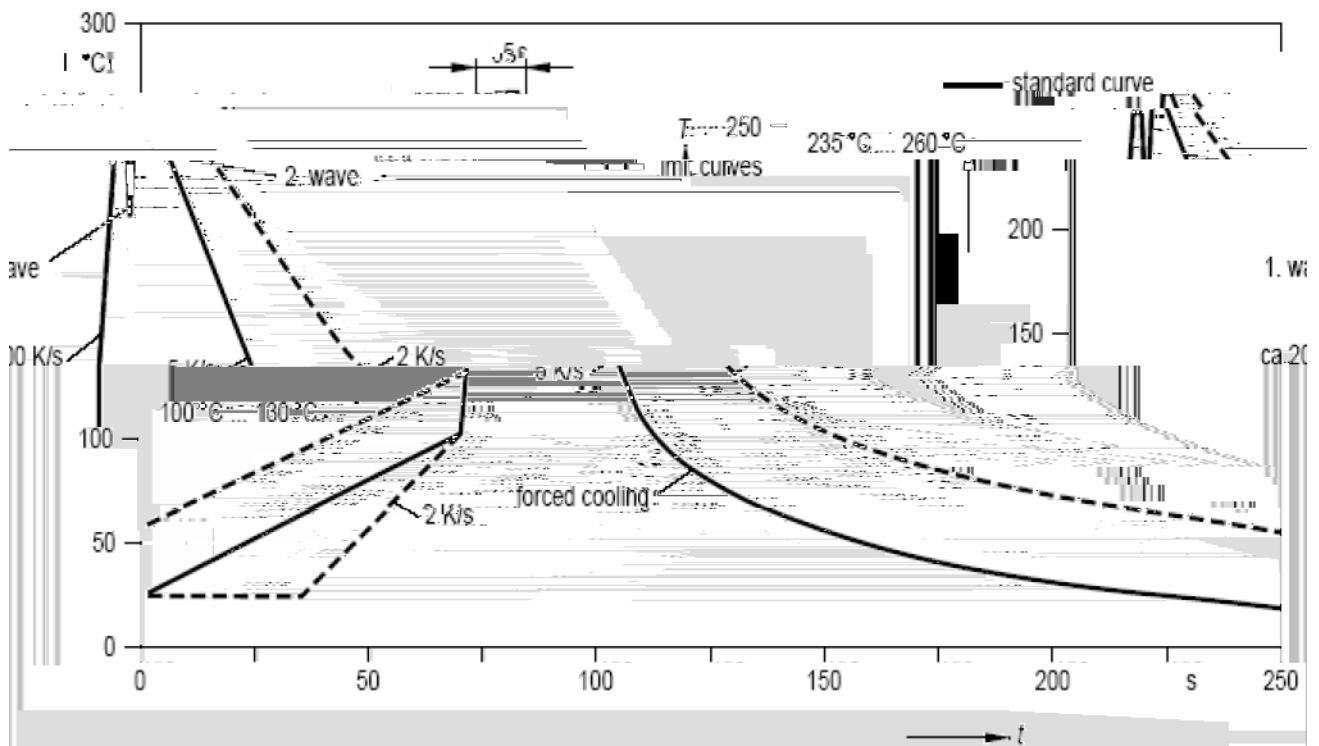

Photo Transistor Diode Specification

●Commodity: Photo Transistor

●Ic(on) Bin Code ($V_{CE}=5V$, $E_e=1mW/cm^2$, $\lambda_p=940nm$)

BIN CODE	Min. (mA)	Max. (mA)
BIN1	2.2	2.6
BIN2	2.6	3.1
BIN3	3.1	3.7
BIN4	3.7	4.4
BIN5	4.4	5.3

NOTE: The Ic(on) guarantee should be added $\pm 15\%$ tolerance.

Typical Electrical / Optical Characteristics Curves (25°C Ambient Temperature Unless Otherwise Noted)

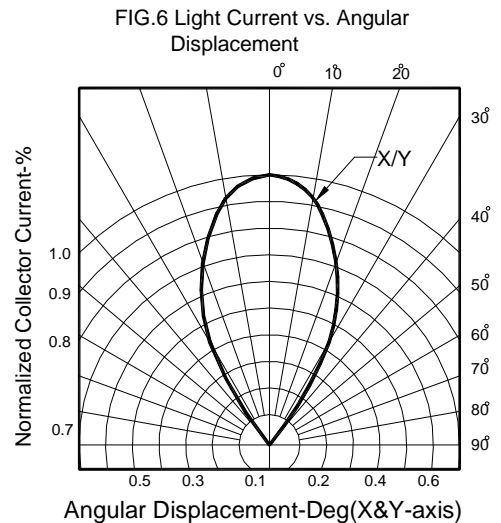
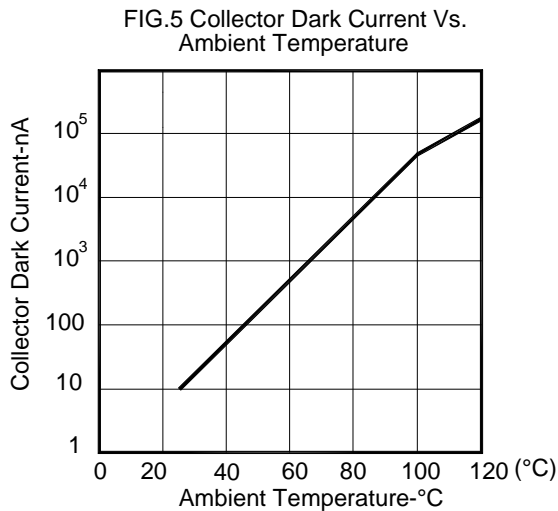
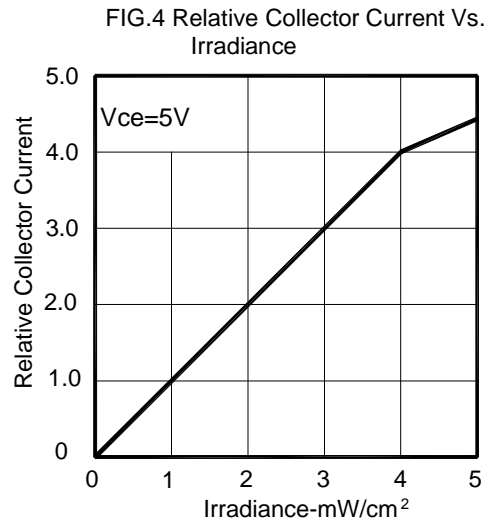
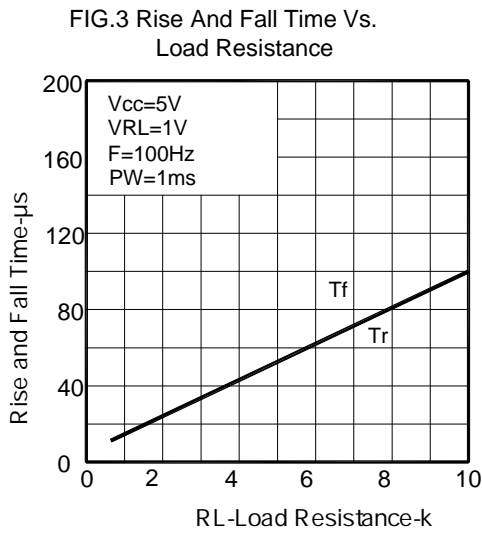
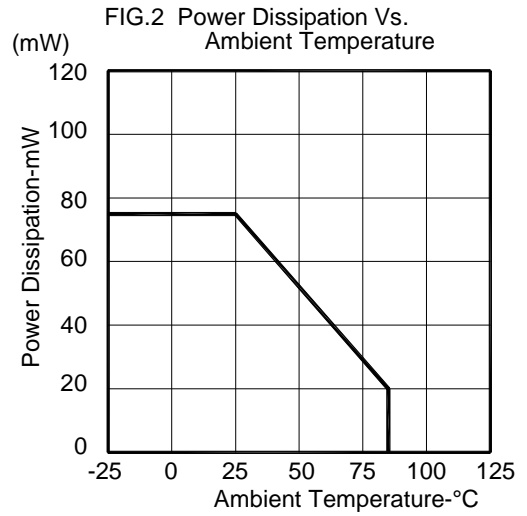
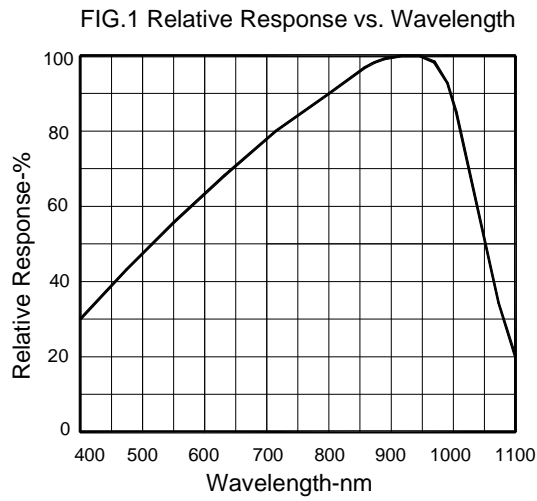

LED MOUNTING METHOD

1. The lead pitch of the LED must match the pitch of the mounting holes on the PCB during component placement. Lead-forming may be required to insure the lead pitch matches the hole pitch. Refer to the figure below for proper lead forming procedures (Fig.1).

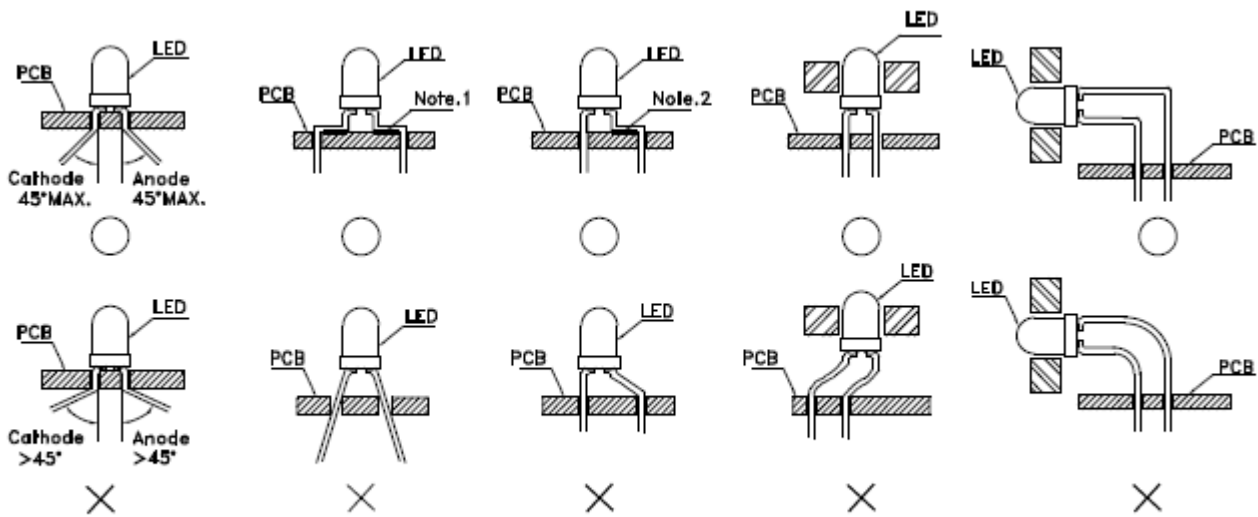

Fig. 1

“ ” Correct mounting method “X” Incorrect mounting method

Note 1-2: Do not route PCB trace in the contact area between the lead frame and the PCB to prevent short-circuits.

2. When soldering wire to the LED, use individual heat-shrink tubing to insulate the exposed leads to prevent accidental contact short-circuit (Fig.2).

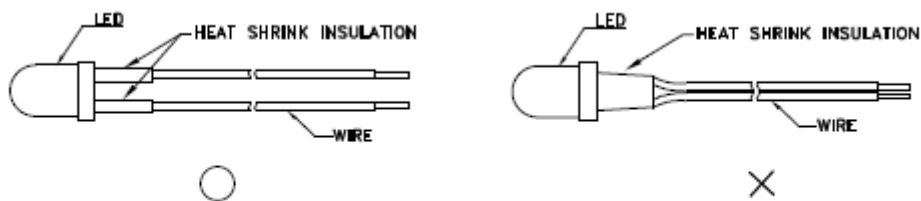

Fig. 2

3. Use stand-offs (Fig.3) or spacers (Fig.4) to securely position the LED above the PCB.

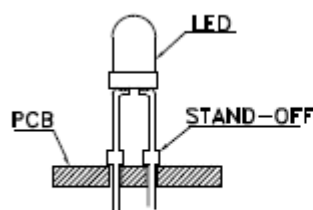

Fig. 3

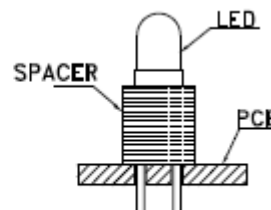

Fig. 4

LEAD FORMING PROCEDURES

1. Maintain a minimum of 2mm clearance between the base of the LED lens and the first lead bend (Fig.5 and Fig.6).

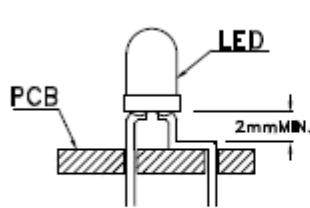

Fig. 5

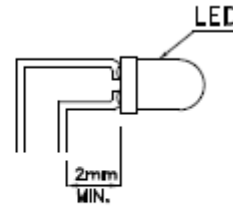

Fig. 6

2. Lead forming or bending must be performed before soldering, never during or after soldering.
3. Do not stress the LED lens during lead-forming in order to fractures in the lens epoxy and damage the internal structures.
4. During lead forming, use tools or jigs to hold the leads securely so that the bending force will not be transmitted to the LED lens and its internal structures. Do not perform lead forming once the component has been mounted onto the PCB (Fig.7).
5. Do not bend the leads more than twice (Fig.8).

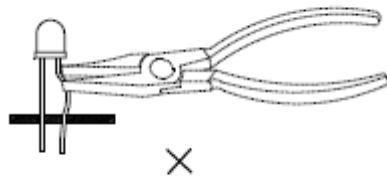

Fig. 7

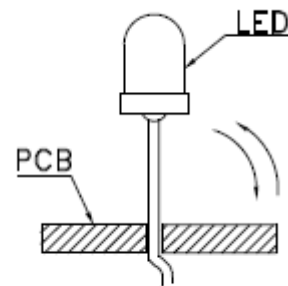

Fig. 8

6. After soldering or other high-temperature assembly, allow the LED to cool down to 50°C before applying outside force (Fig.9). In general, avoid placing excess force on the LED to avoid damage. For any questions please consult with LIGHT representative for proper handling procedures.

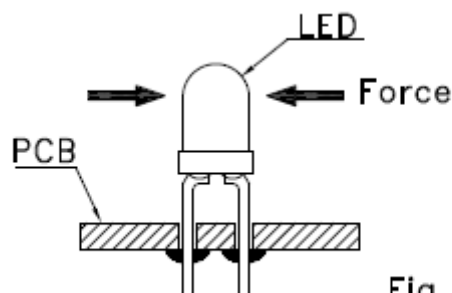
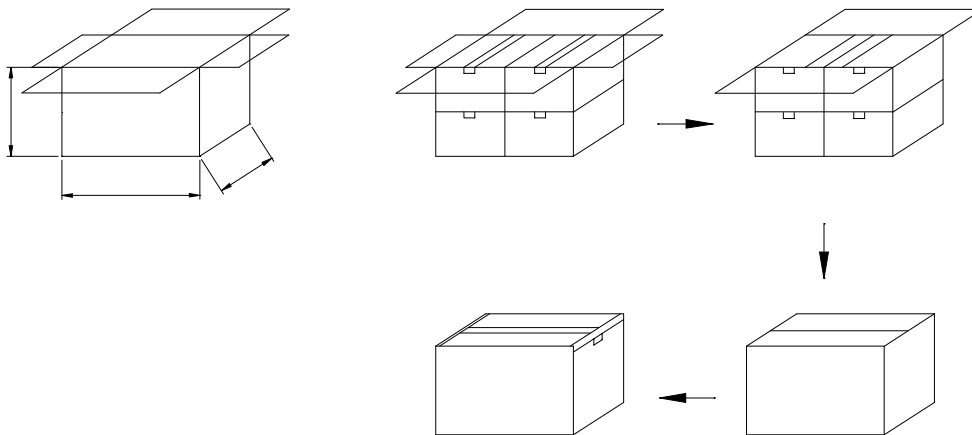
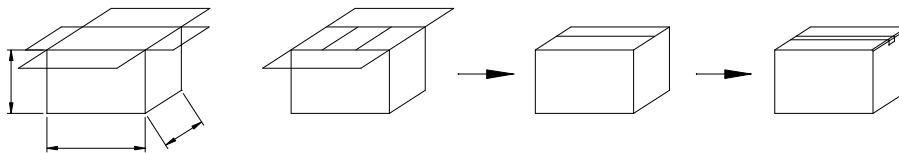
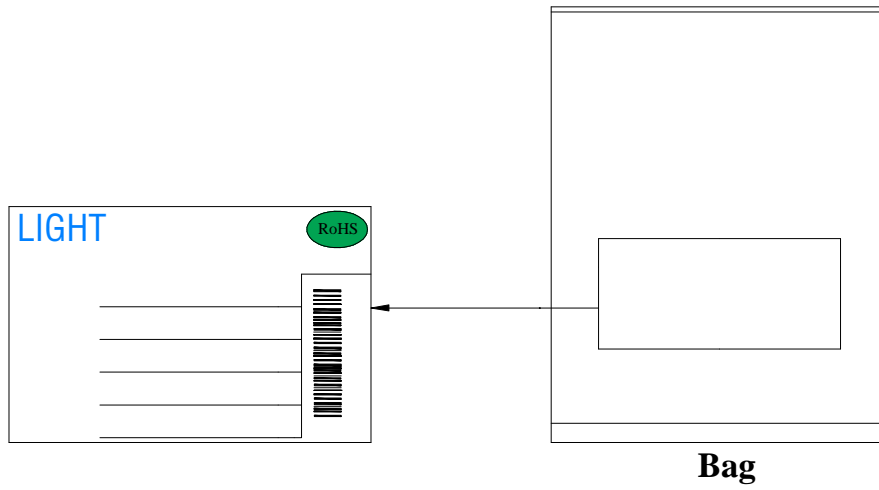

Fig. 9

PACKAGE



Bag minimum volume (pcs / Bag)	Bag volume (pcs / Bag)	Inner box volume (Bag / box)	Outer carton volume (Box / Carton)
500	1000	10	4