

LIGHT ELECTRONICS CO., LTD.



| | | | |
|-----------------|------------------------|--|--|
| Part No. | LG-IRM2A438KSF3 | | |
|-----------------|------------------------|--|--|

1

IRM2A438 SF3 PIN
 IC
 REACH RoHS

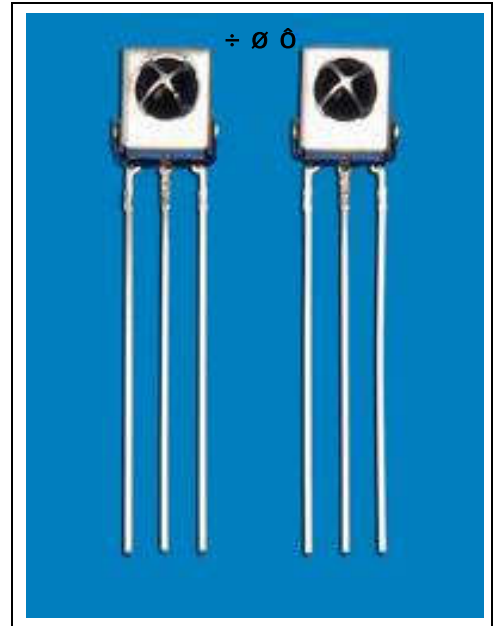

2

2.7-5.5V

3

TTL CMOS
 :
 (MP3 MP4, ä ä æ ç è
 é ê ë ì í î é ê í ç ì
 ð ñ ò

4

ø ø :

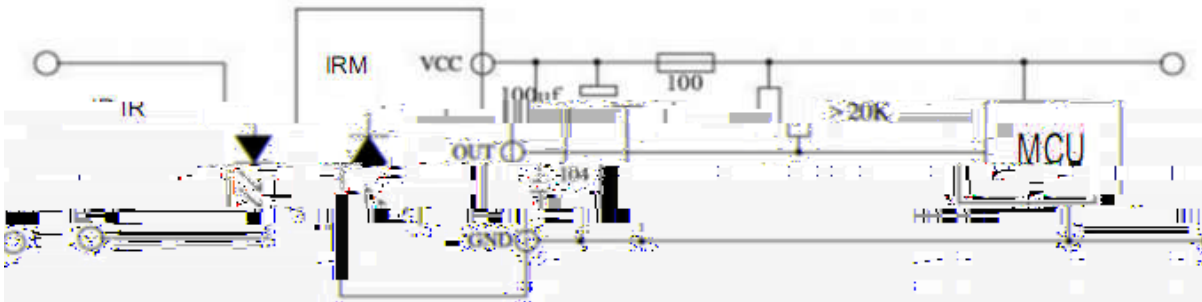

5 ø ø ø

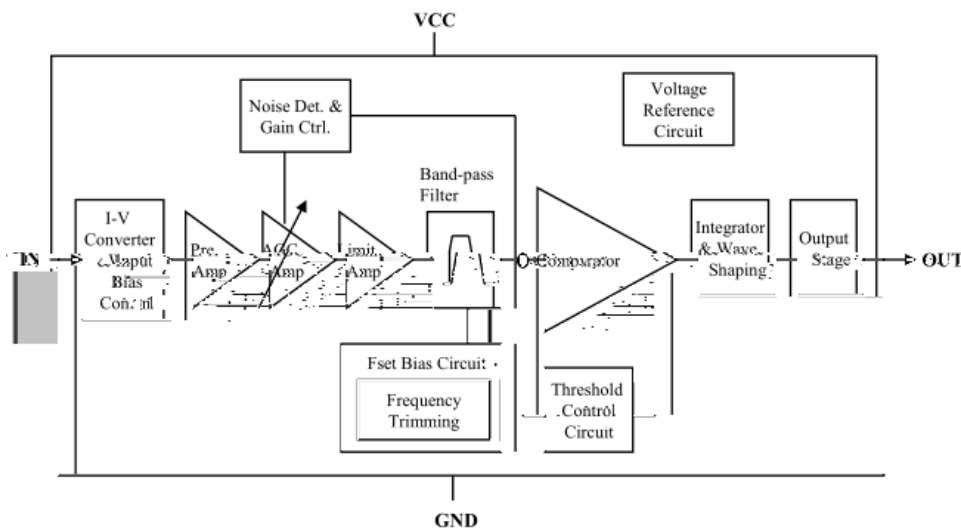

LIGHT ELECTRONICS CO., LTD.

L

LIGHT ELECTRONICS CO., LTD.

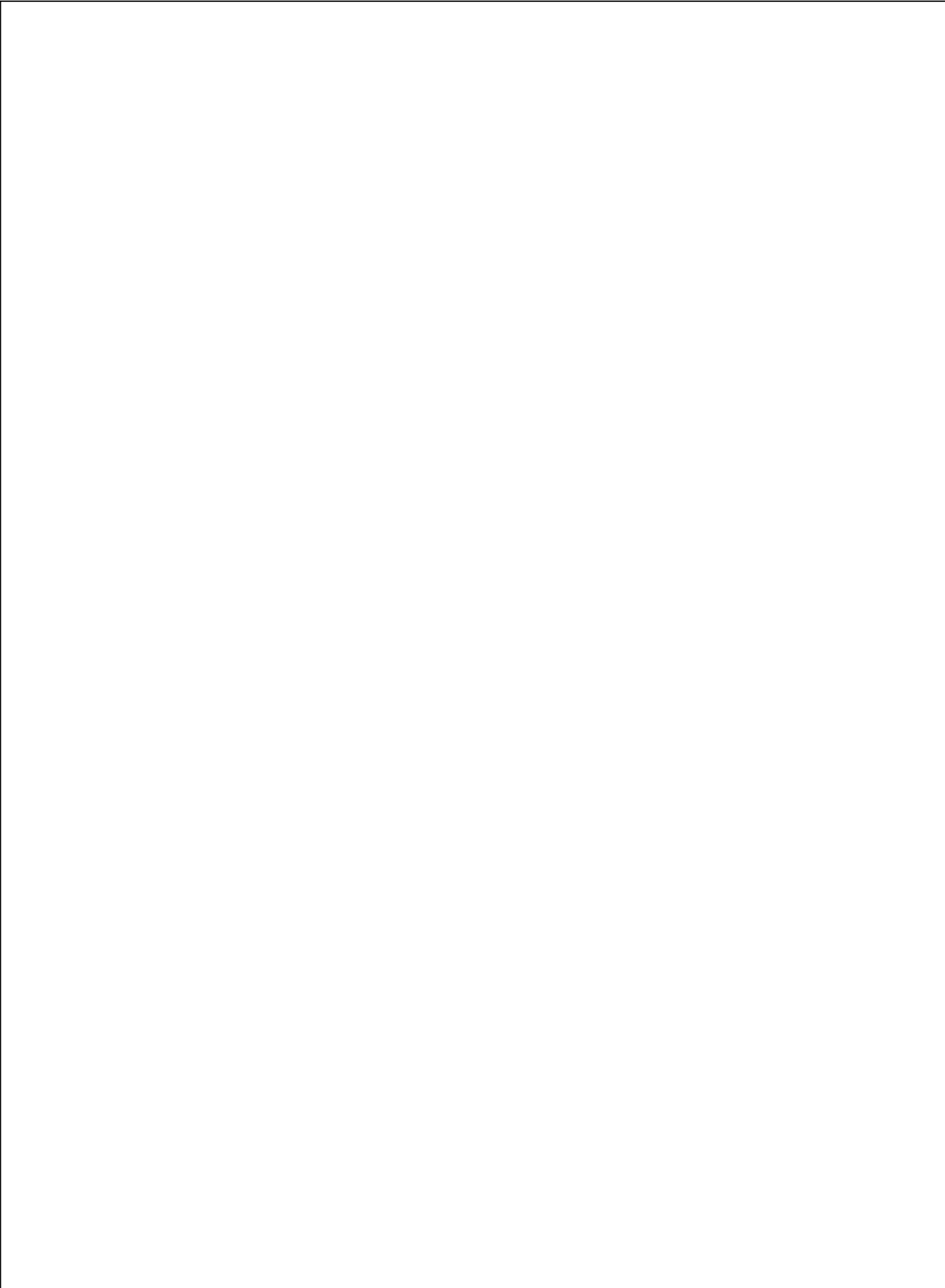

1ã

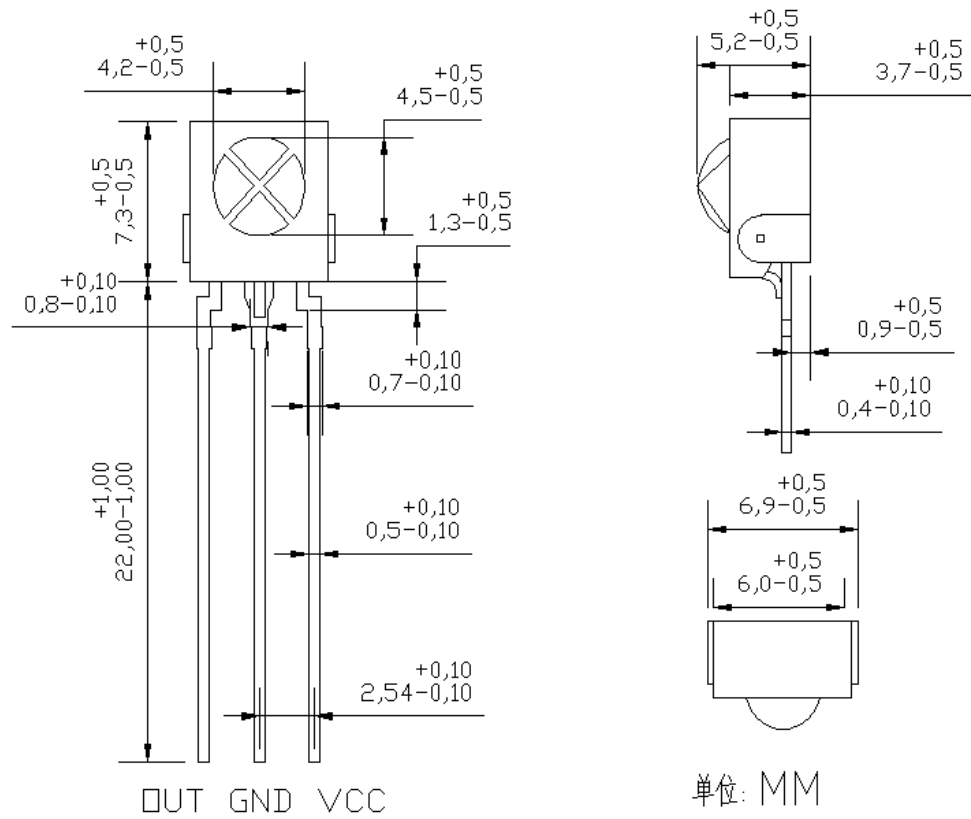

15

1è.

: 26pü 5 , ,

2

3

16.

1è. è ô ï

150mm× 190mm

ú 5pPCS

2è.

ô

ú 5pPCS

1p

ã

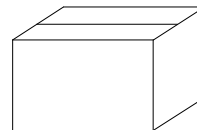
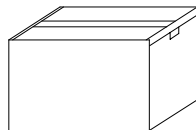
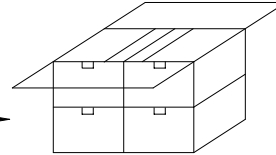
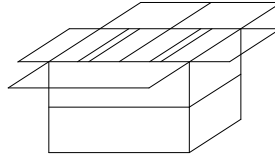
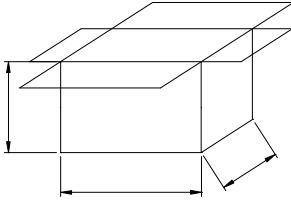
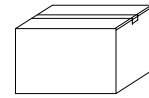
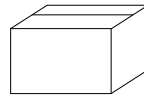
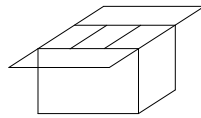
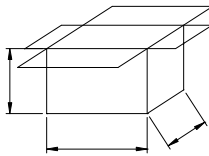
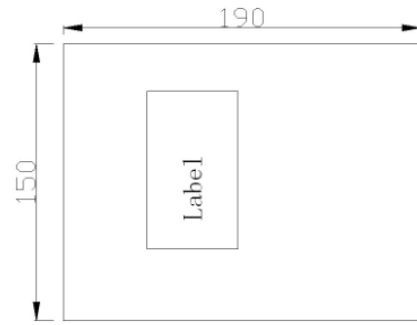

| | | |
|------------|-----------|----------|
| (pcs /) | (/) | (/) |
| 500 | 10 | 4 |