

SL-T4233PDB020-L395-E

PHOTO Diode

DATA SHEET

SPEC. NO. : SZ21110202
DATE : 2021/11/02
REV. : A/0

Approved By:

Checked By:

Prepared By:

Features

- Pb free product—RoHS compliant
- High Photo Sensitivity
- Reliable and rugged
- Long life – solid state reliability
- Sensitivity angle: 85°

Package Dimension

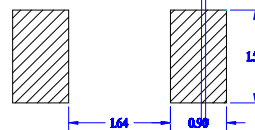

Recommended Soldering patterns

Part NO.	Chip Material	Lens Color
SL-T4233PDB020-L395-E	Silicon	Black

Notes:

1. All dimensions are in millimeters.
2. Tolerance is ± 0.10 mm unless otherwise noted.
3. Specifications are subject to change without notice.

Electrical Optical Characteristics at Ta=25

PARAMETER	SYMBOL	MIN.	TYP.	MAX.	UNITS	TEST CONDITIONS
Reverse Light Current	I_L	21	26	---	μA	$V_R=5\text{V}$ $E_e=1\text{mW}/\text{cm}^2$
Reverse Dark Current	I_D	---	---	30	nA	$V_R=10\text{V}$ $E_e=0\text{mW}/\text{cm}^2$
Reverse Voltage	$V_{(R)}$	30	---	---	V	I_R
Forward Voltage	V_F	---	---	1.5	V	$I_F=20\text{mA}$
	$1/2$	75	85	95	Deg.	(Note 1)
	$1/2$	25	35	45	Deg.	
Rise Time/ Fall Time	tr/tf	---	50	---	ns	$V_R=10\text{V}$
Total Capacitance	C_T	---	12	---	pF	$V_R=5\text{V}$ $E_e=0\text{mW}/\text{cm}^2$ $f=1.0\text{MHz}$

Typical Electrical / Optical Characteristics Curves
(25 Ambient Temperature Unless Otherwise Noted)

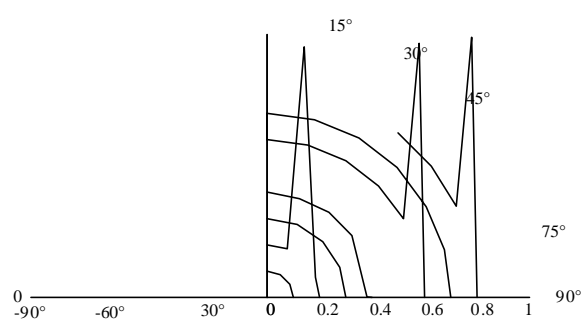
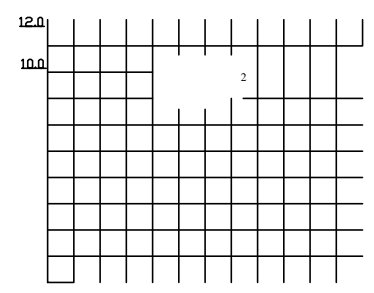
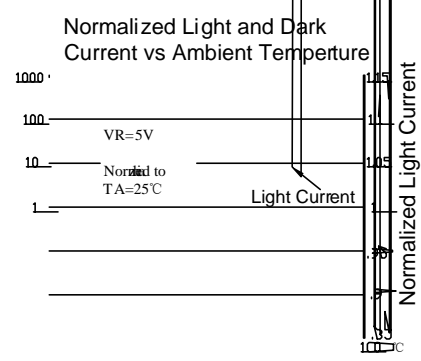
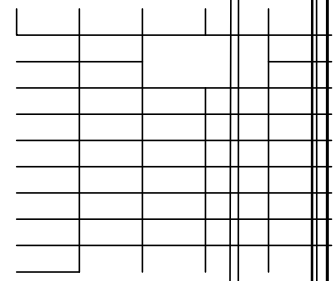
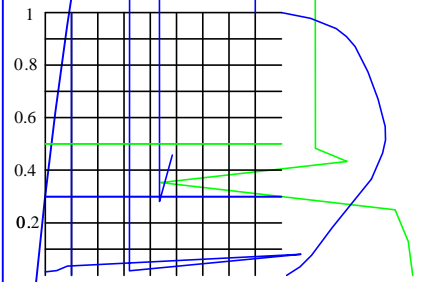
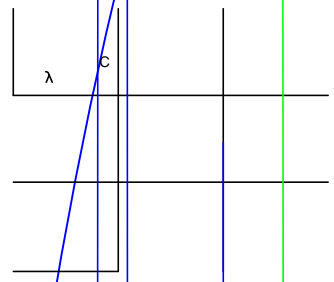
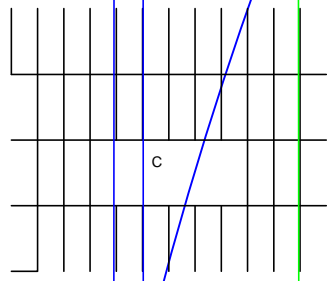
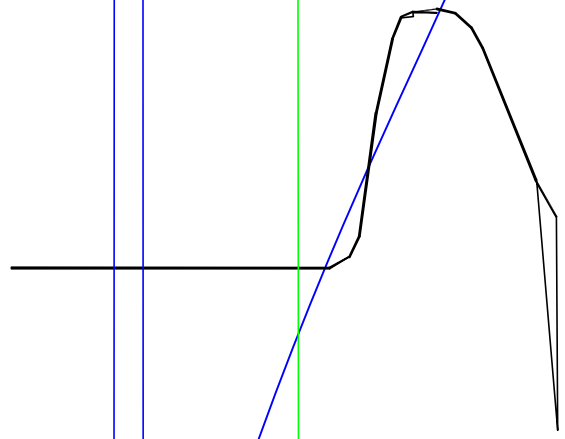

Reverse Light Current Bin Code ($V_R=5V$, $E_e=1mW/cm^2$, $p=940nm$)

BIN CODE	Min.(μA)	Max.(μA)
31	21	26
32	26	31
33	31	37

NOTE: The I_L guarantee should be added $\pm 15\%$ tolerance.

Label Explanation

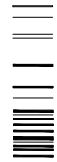

Carrier Tape Specifications (Loaded Quantity: 2300pcs/reel)

ITEM	W	A0	A1	B0	B1	K0	E	F	D0	D1	P0	P1	P2	T
DIM	12.00	4.35	2.05	4.40	4.10	3.65	1.75	5.50	1.50	1.60	4.00	8.00	2.00	0.30
TOLE	+0.10 -0.10	+0.10 -0.10	+0.10 -0.10	+0.10 -0.10	+0.10 -0.10	+0.10 -0.10	+0.10 -0.10	+0.10 -0.10	+0.10 -0.10	+0.10 -0.10	+0.10 -0.10	+0.10 -0.10	+0.10 -0.10	+0.05 -0.05

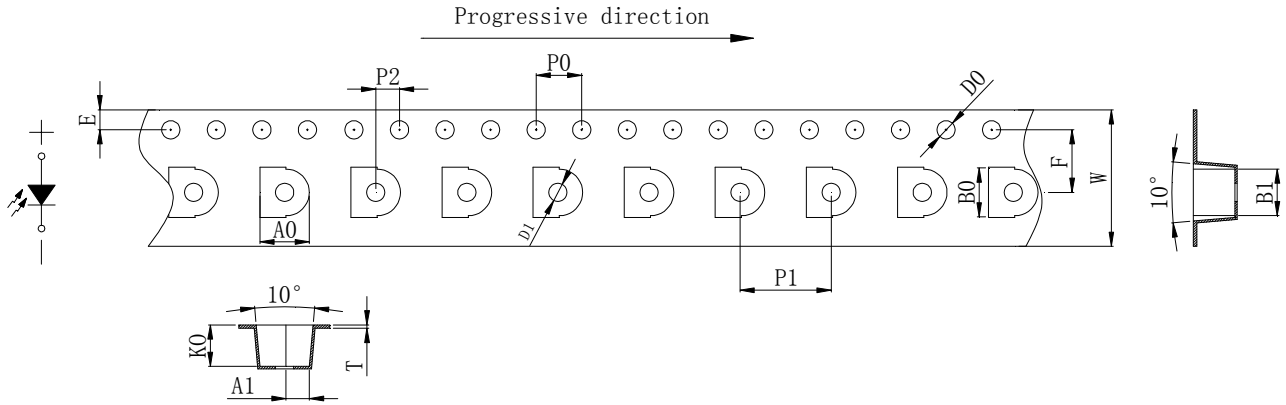

Note: Tolerance unless mentioned is ± 0.1 mm; Unit = mm

Moisture Resistant Packaging



