

# **SL-T2016IRPTB009-L75**

## **DATA SHEET**

SPEC. NO. : SZ21073101  
DATE : 2021/07/31  
REV. : A/1

Approved By:

Checked By:

Prepared By:





LIGHT for dehumidification.

### 2. Caution in ESD:

Static Electricity and surge damages the LED. It is recommend to use a wrist band or anti-electrostatic glove when handling the LED. All devices, equipment and machinery must be properly grounded.

### 3. Pulse Forward Current:

Pulse Width 0.1ms and duty 10%.

## Typical Product Characteristics (Ta=25 )-Emitter

Characteristics	Symbol	Min.	Typ.	Max.	Unit	Test condition
Forward Voltage	$V_F$	-	2.0	2.5	V	$I_F=7mA$
Reverse Current	$I_R$	-	-	10	$\mu A$	$V_R=2V$
Center Wavelength	$\lambda_p$	-	940	-	nm	$I_F=7mA$
Spectrum Width of Half Value	$D_p$	-	5	-	nm	$I_F=7mA$

**Note:** Tolerance of Forward Voltage:  $\pm 0.1V$ .

## Typical Product Characteristics (Ta=25 )-Detector

Characteristics	Symbol	Min.	Typ.	Max.	Unit	Test condition
Collector Emitter Breakdown Voltage	$BV_{CEO}$	85	-	-	V	$I_C=100\mu A$ $L^*=0$
Emitter Collector Breakdown Voltage	$BV_{ECO}$	8.2	-	-	V	$I_E=10\mu A$ $L^*=0$
Collector Emitter Dark Current	$I_{CEO}$	-	2	30	nA	$V_{CE}=20V, L^*=0$ Fig. 2

**Note:**  $L^*=0$  (zero light condition)



Optical Characteristics (Ta=25°C)

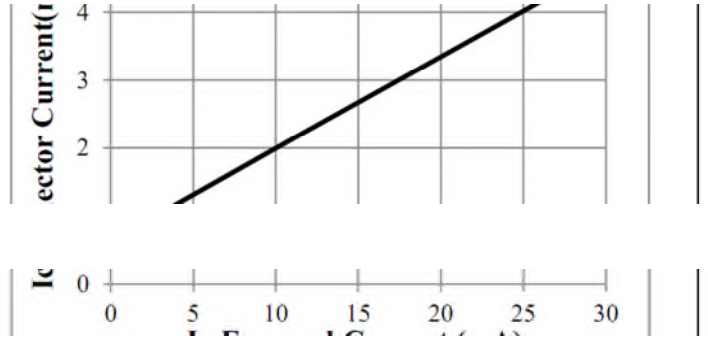
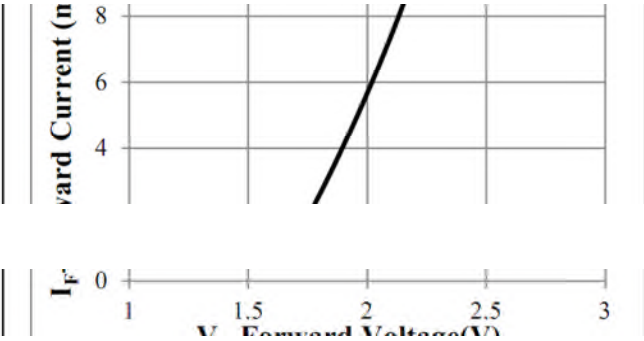

Note:  $V_{CE}=5V$ ,  $D=1\text{ms}$ , Pulse width 0.1ms  
5% Duty Cycle

3 Forward Voltage vs. Ambient Temperature

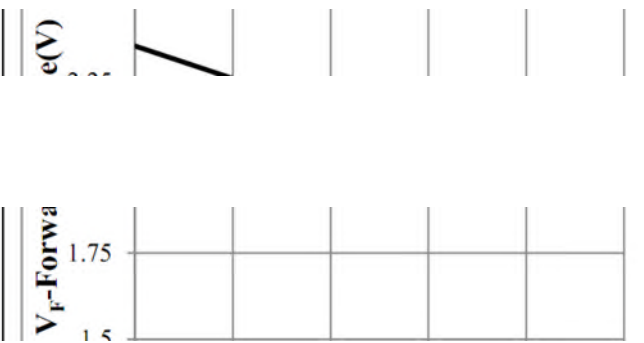

4 Collector Current vs. Ambient Temperature

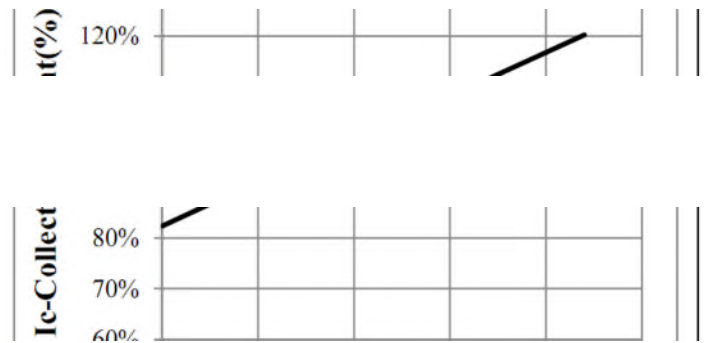

**Output Current Test Condition (Ta=25°C)**

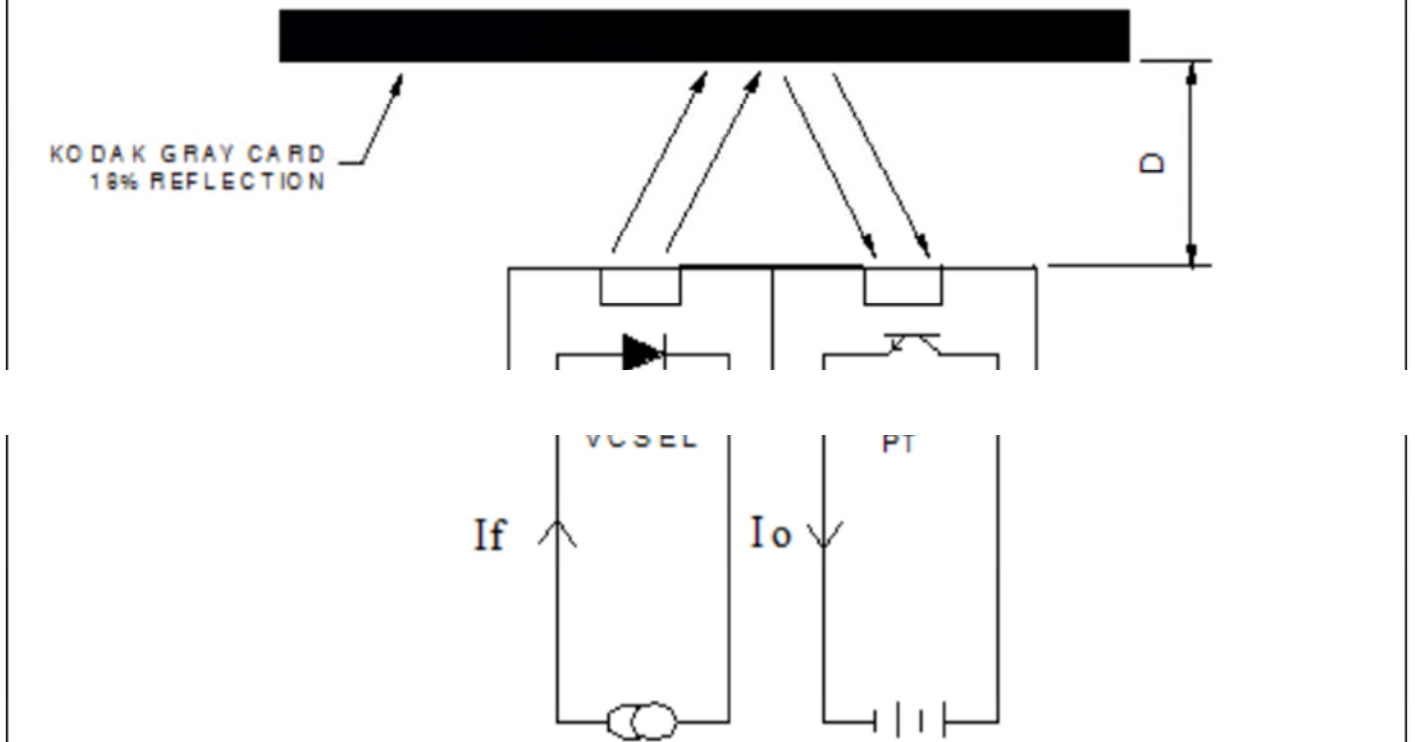

Fig.1 : Test Condition: D = 1mm 18% Gray Card,  $I_F=7$  mA,  $V_{CE} = 5V$ , Pulse width 0.1ms, 5% Duty Cycle

**Dark Current Test Condition (Ta=25°C)**

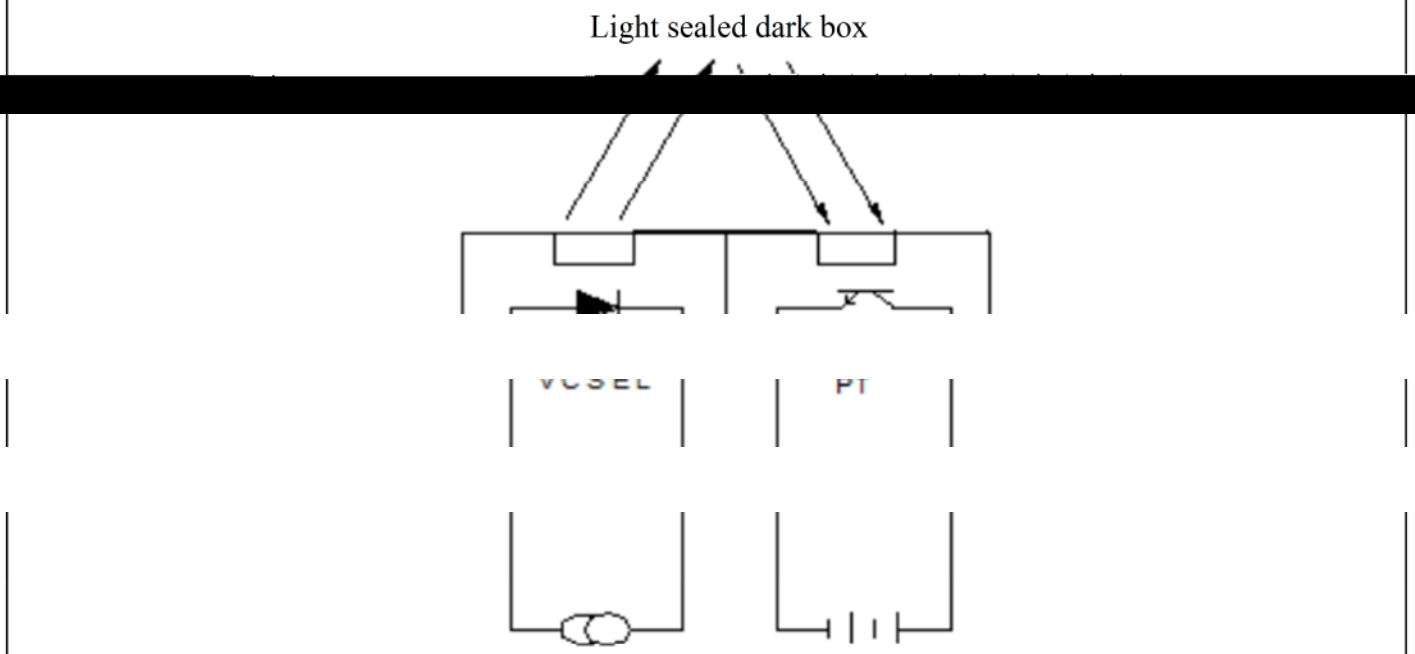
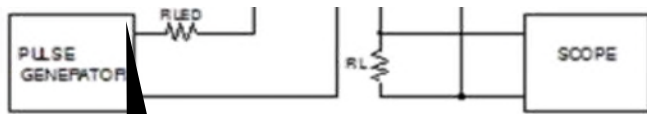
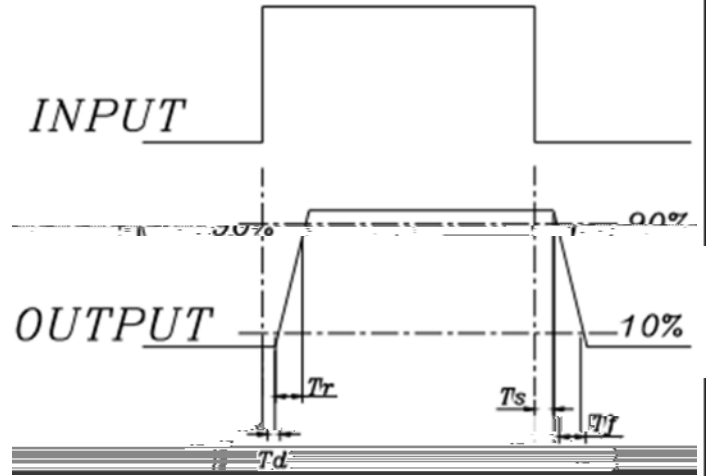
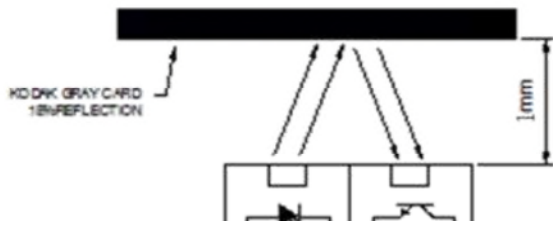

Fig. 2: Test Condition:  $I_{LED}=9$  mA,  $V_{CE} = 5V$ , Pulse width 0.1ms, 5% Duty Cycle

Response Time Test Condition (T<sub>a</sub> = 25°C)



Label Explanation

Light Universal Label  
(Reel Label)

Customer Defined Label  
(Aluminum Moisture Proof Bag Label)

LIGHT	RoHS
Light Electronics CO., LTD.	
MODEL NAME:	LOT NO.: 
QUANTITY:	
PACKING DATE:	
REVISION:	

LIGHT	RoHS
Light Electronics CO., LTD.	
MODEL NAME:	LOT NO.: 
QUANTITY:	
PACKING DATE:	
CUSTOMER P/N:	

Reel Dimension

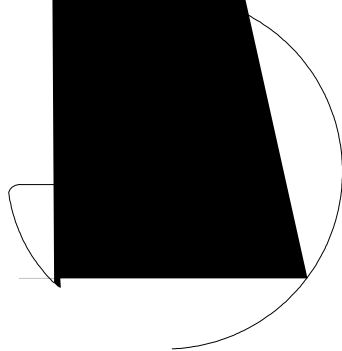

Note: Tolerance, unless mentioned, is ±0.2mm; Unit = mm





Condition of Reflow Soldering for LED

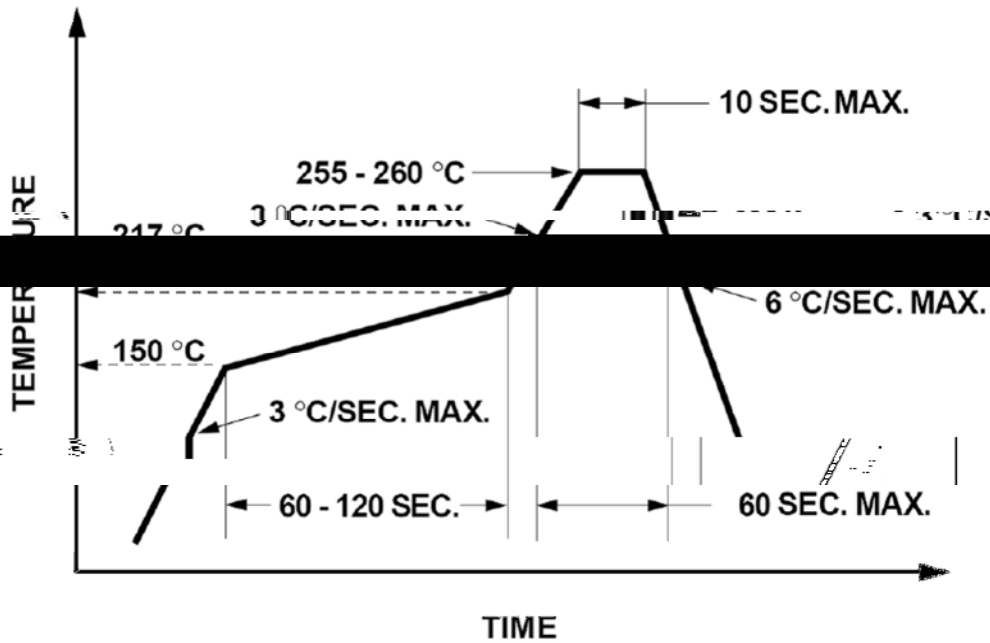

1. Reflow soldering should not be done more than two times.
2. When soldering, do not put stress on the LEDs during heating.

Soldering iron

1. When hand soldering, the temperature of the iron must less than 300°C for 3 seconds.
2. The hand solder should be done only once.

Repairing

Repair should not be done after the LEDs have been soldered. When repairing is unavoidable, a double-head soldering iron should be used (as below figure). It should be confirmed beforehand whether the characteristics of LEDs will or will not be damaged by repairing.

