

LG-T3535RGBA-TD

SPEC.NO. : SZ19101201
DATE : 2020/04/24
REV. : A/1

Approved By:

Checked By:

Prepared By:

LG-T3535RGBA-TD

TOP Full-color LED

Technical Data Sheet

受

hese products are full-color SMD components with black frame and white refractor, high contrast ,which are featured by multiple waterproof performance, good reliability, long lifespan and wide viewing angle.They are designed for outdoor display and decoration applications.

Features:

	Red	Green	Blue
Material:	AlGaInP	InGaN	InGaN

- Encapsulation: Epoxy Resin
- Soldering methods: Pb-Free reflow soldering
- 受
High Luminous Intensity, Low Power Dissipation, Good Reliability and Long Life
- RoHS
Complied with RoHS Directive

Catalogue

Electrical Characteristics.....

LIGHT

Typical Characteristics Curves

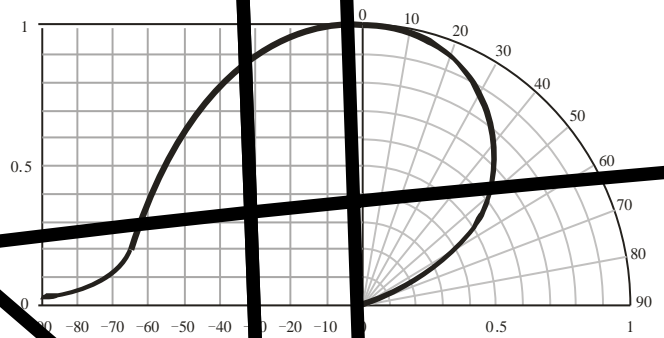

Product Design and Operating Recommendation

1 mm
Product design Unit: mm

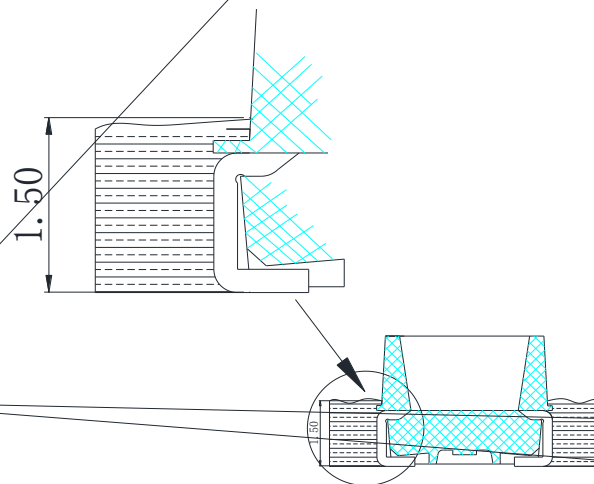
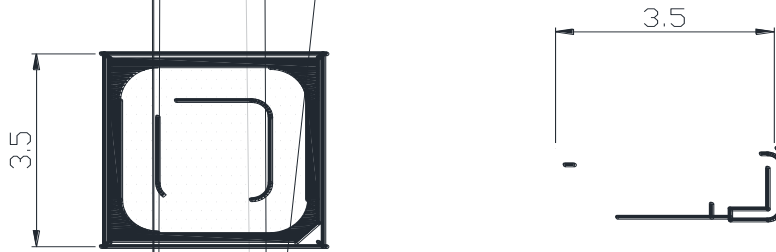

1

Packaging (1)

◇ Carrier Tape

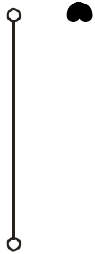

◇ Details Of Carrier Tape

Progressive Direction

◇ Reel Dimension

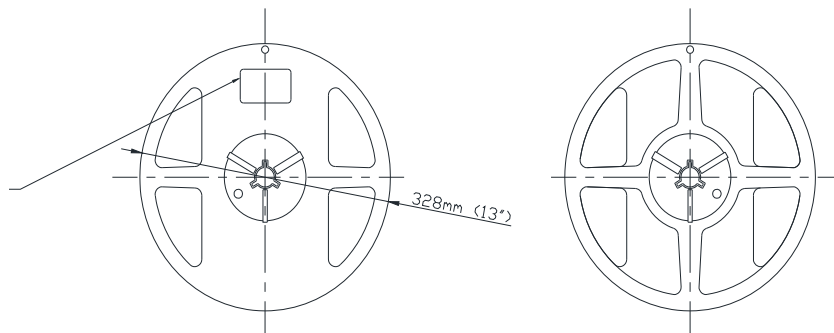



Cardboard Box

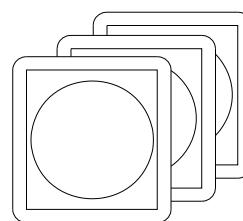
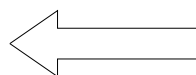
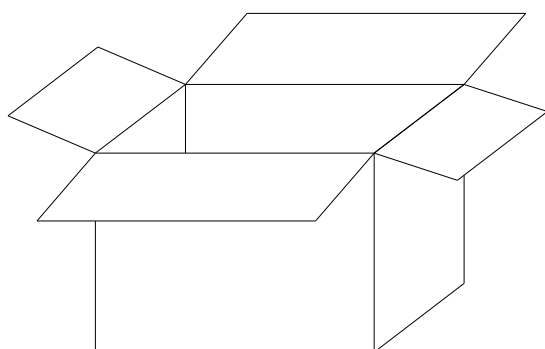

Label Explanation

LIGHT

LIGHT

2

Guideline for Soldering (2)

Reflow soldering should not be done more than one time.

LED 代

Stress on the LEDs should be avoided during heating in the reflow soldering process.

完

After soldering, do not deal with the product before its temperature drop down to room temperature.

3.

Cleaning

		30		3	50
30	伤			LED	

It is recommended that alcohol Anhydrous ethanol be used as a solvent for cleaning after soldering. Cleaning is to go under 30 for 3 minutes or 50 for 30 seconds. When using other solvents, it should be confirmed beforehand whether the solvents will dissolve the package and the resin or not.

300W 后 受 LED

后 LED

Ultrasonic cleaning is also an effective way for cleaning. The influence of Ultrasonic cleaning on LED depends on factors such as ultrasonic power. Generally, the ultrasonic power should not be higher than 300W, otherwise it will cause LED damage. Before cleaning, a pre-test should be done to confirm if any damage to LEDs will occur.

* PCB PCB

*Note: This general guideline may not apply to all PCB designs and configurations of all soldering equipment. The technique in practice is influenced by many factors, it should be specialized base on the PCB designs and configurations of the soldering equipment.

LIGHT

(2)

Precautions (2)

3.

Design Consideration

- LED 后 受
- In designing a circuit, the current through each LED must not exceed the absolute maximum rating specified for each LED. In the meanwhile, resistors for protection should be applied, otherwise slight voltage shift will cause big current change which will probably lead to damage.
- A 备 LED B 受 LED
LED V_F LED

It is recommended to use Circuit A which regulates the current flowing through each LED rather than Circuit B. When driving LEDs with a constant voltage in Circuit B, the current through the LEDs may vary due to the variation in Forward Voltage (V_F) of the LEDs. In the worst case, some LED may be subjected to stress in the excess of the Absolute Maximum Rating.

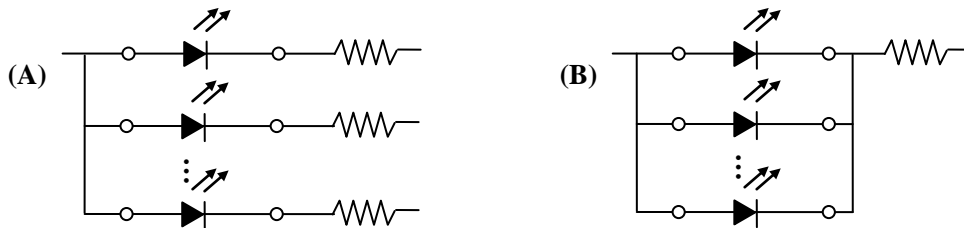

- LED LED
- Thermal Design is paramount importance because heat generation may result in the Characteristics decline, such as brightness decrease, Color change and so on. Please consider the heat dissipation when making the system design.

4.

Reverse voltage protection

- LED LED
LED LED
LED 10V

In general, the reverse current of LED is very small, which won t affect the normal use of components. But when it is often suffered the reverse voltage which exceeds the limit of the component then it will be damaged.

Such as the reverse current increase rapidly. And it will cause the string light when the screen is black. So please pay attention to controlling the reverse voltage which less than 10V is recommended.

5.

The safe temperature for LEDs working

- LED 冷 55 75 are used in hot environment for a long time, they will be disabled easily. When LEDs are used in a high density array, we suggest that the LEDs lower than 75 .

6.

Others

- 受 受

When handling the product, touching the encapsulation with bare hands will not only contaminate its surface, but also have an effect on its optical characteristics. Excessive force to the encapsulation might result in catastrophic failure of the LEDs due to die breakage or wire deformation. For this reason, please do not put excessive stress on LEDs, especially when the LEDs are heated such as during Reflow Soldering.

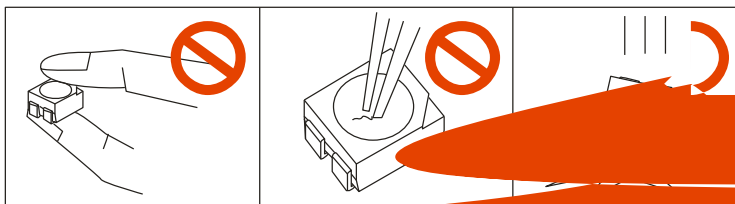

y LED