

LG-IRM2B238KSF3

IC

PIN

RoHS REACH

2.7-5.5V

TTL CMOS

(MP3 MP4,)

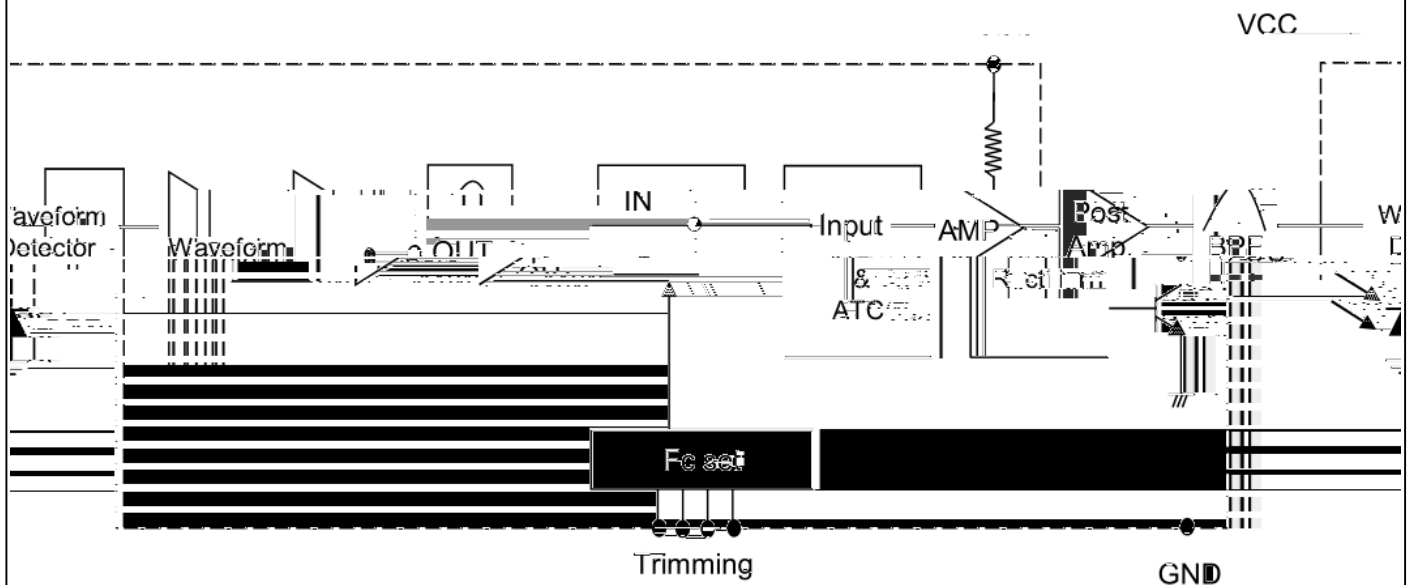
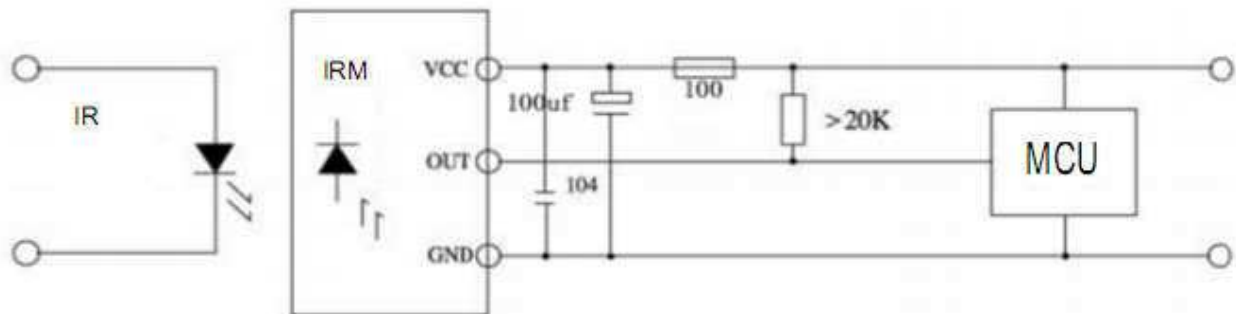
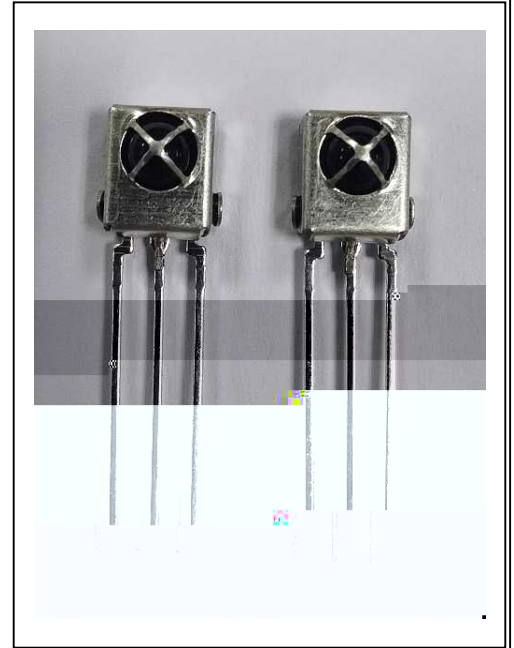

			Min	Typ	Max			
		Icc	No Input Signal		0.2	0.5	0.7	mA
	L	0°	16	18	---	m		
	L	45°	8	9	---			
	L	45°	8	9	---			
		f ₀	---	37.9	---		kHz	
BPF	fbw	fin=37.9kHz		---	7.0	---	kHz	
BPF	fc	---		-5	f ₀	+5	%	
		V _{ol}	Iosink=2.0mA		---	0.2	0.4	V
		V _{oh}	---		4.8	5.0	---	V
		Av_max	fin=37.9kHz		60	64.5	68	dB
		R _{pul}	---		---	50	---	k
		T _{pw}	Vin =500 pp		400	600	800	μS

1m 40W

200±50Lux

Toshiba/NEC/Mitsubishi/RC5_Philips/Sony 12bit/Zenith/RC6/Continuous Code/Sony 15bit/
Sony 20bit/RCA/RCMM.

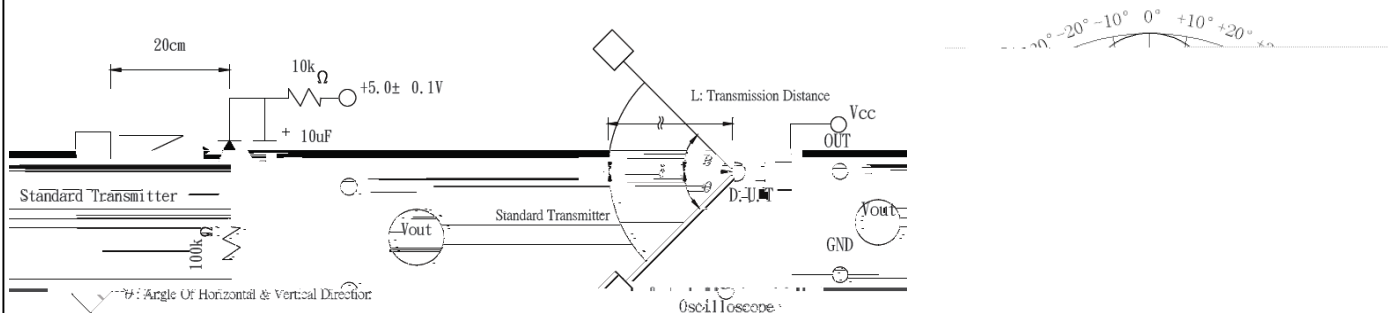

		Min.	Typ.	Max.	
	V _{DD}	2.7	---	5.5	V
	FM	---	37.9	---	kHz
	Topr	---	25	---	

	V _{DD}	6.0	V
	T _{stg}	-40~100	
	T _{sol}	260±5 5S	

*

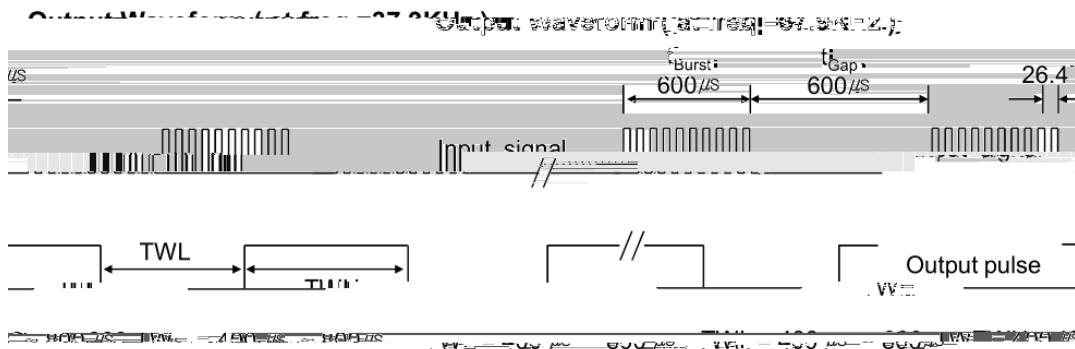

* $t_{pi} \geq 10/f_0$ is recommended for optimal function.

Minimum Burst Length t_{burst} (number of pulses per burst)	200us
Minimum Burst Gap time t_{burst_gap} (number of pulses per burst) between two burst	300us

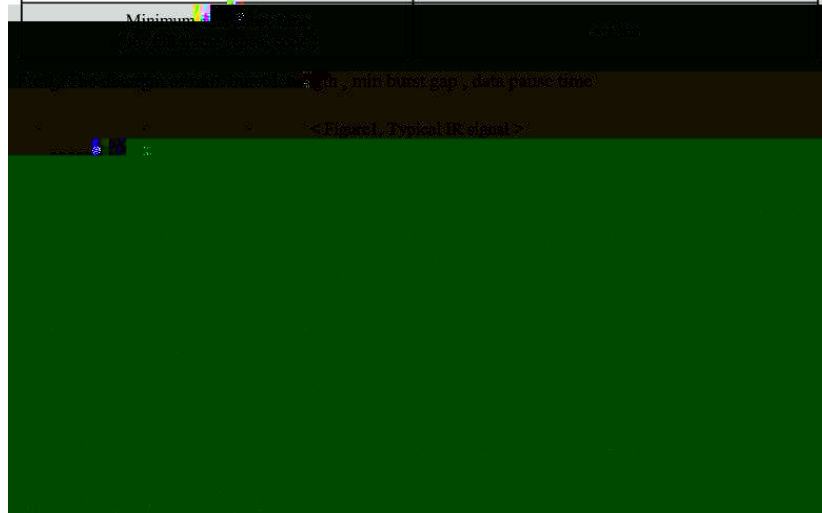

	260 ±5	5	20	20
	100PF, 1.5k , 4KV,	---	20	20
	10-50Hz/1min 1.5mm X Y Z/30min	30	20	20
	85 ±3	240	20	20
	-20 ±3	240	20	20
	85 85%	240	20	20
	-20 30 85 30	10	20	20
	2.5N 2	---	20	20

LI

LIGHT ELECTRONICS CO., LTD.

LI

1

150mm × 190mm

500PCS

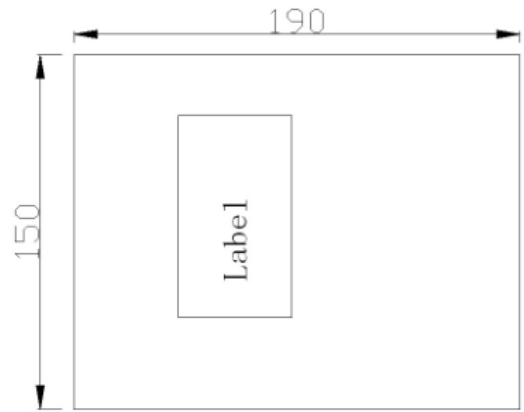

2

500pcs/

10 /

4 /

